



^ WARNING

This User's Manual contains safety information and instructions for your trailer.

You must read this manual before loading or towing your trailer.

You must follow all safety precautions and instructions.

Boss Trailers
6825 Lamar Rd.
Reno, TX 75462
www.bosstrailers.com

Contents

1. GENERAL SAFETY INFORMATION	7
1.1. SAFETY ALERT SYMBOLS AND SIGNAL WORDS.....	7
1.2. MAJOR HAZARDS	7
1.2.1. IMPROPER SIZING OF THE TRAILER TO THE TOW VEHICLE.....	7
1.2.2. DRIVING TOO FAST.....	8
1.2.3. FAILURE TO ADJUST DRIVING BEHAVIOR WHEN TOWING A TRAILER.....	8
1.2.4. TRAILER NOT PROPERLY COUPLED TO THE HITCH.....	8
1.2.5. PROPER USE OF SAFETY CHAINS	9
1.2.6. PROPER CONNECTION OF BREAKAWAY BRAKE	9
1.2.7. MATCHING TRAILER AND HITCH	9
1.2.8. WORN TIRES, LOOSE WHEELS, AND LUG NUTS	9
1.2.9. IMPROPER LOADING	10
1.2.10. UNSAFE LOAD DISTRIBUTION	11
1.2.11. SHIFTING CARGO.....	11
1.2.12. INAPPROPRIATE CARGO.....	12
1.2.13. INOPERABLE BRAKES, LIGHTS OR MIRRORS	12
1.2.14. HAZARDS FROM MODIFYING YOUR TRAILER.....	12
1.2.15. SAFETY WARNING LABELS ON YOUR TRAILER	13
1.2.16. TRAILER TOWING GUIDE.....	15
1.2.17. REPORTING SAFETY DEFECTS.....	15
1.3. SAFE TRAILER TOWING GUIDELINES.....	15
2. TIRE SAFETY INFORMATION.....	16
2.1. STEPS FOR DETERMINING CORRECT LOAD LIMIT – TRAILER.....	16
2.1.1. TRAILERS 10,000 POUNDS GVWR OR LESS	16
2.1.2. TRAILERS OVER 10,000 POUNDS GVWR.....	16
2.2. STEPS FOR DETERMINING CORRECT LOAD LIMIT – TOW VEHICLE.....	17
2.3. TIRE SAFETY - EVERYTHING RIDES ON IT	17
2.3.1. SAFETY FIRST–BASIC TIRE MAINTENANCE	17

2.3.2.	FINDING YOUR VEHICLE'S RECOMMENDED TIRE PRESSURE AND LOAD LIMITS	17
2.3.3.	UNDERSTANDING TIRE PRESSURE AND LOAD LIMITS	17
2.3.4.	CHECKING TIRE PRESSURE	18
2.3.5.	STEPS FOR MAINTAINING PROPER TIRE PRESSURE	18
2.3.6.	TIRE SIZE	18
2.3.7.	TIRE TREAD.....	18
2.3.8.	TIRE BALANCE AND WHEEL ALIGNMENT	18
2.3.9.	TIRE REPAIR.....	18
2.3.10.	TIRE FUNDAMENTALS	18
2.3.11.	TIRE SAFETY TIPS.....	21
3.	COUPLING TO THE TOW VEHICLE	22
3.1.	USE AN ADEQUATE TOW VEHICLE AND HITCH.....	22
3.2.	TRAILER INFORMATION / CERTIFICATION / VIN LABEL	22
3.3.	COUPLING AND UNCOUPLING THE TRAILER	23
3.3.1.	VARIOUS COUPLER DESIGNS.....	24
3.3.2.	TRAILER WITH BALL-HITCH COUPLER	24
4.	LOADING THE TRAILER.....	35
4.1.	TONGUE WEIGHT.....	35
4.2.	SECURING THE CARGO.....	37
4.2.1.	DISTRIBUTING THE CARGO (OPEN TRAILER).....	37
5.	CHECKING THE TRAILER BEFORE AND DURING EACH TOW	39
5.1.	PRE-TOW CHECKLIST.....	39
5.2.	MAKE REGULAR STOPS	39
6.	BREAKING-IN A NEW TRAILER	40
6.1.	RETIGHTEN LUG NUTS AT FIRST 10, 25 & 50 MILES	40
6.2.	ADJUST BRAKE SHOES AT FIRST 200 MILES	40
6.3.	SYNCHRONIZING THE BRAKE SYSTEMS	40
6.4.	ACCESSORY BATTERY	40
7.	INSPECTION, SERVICE & MAINTENANCE	42
7.1.	INSPECTION, SERVICE & MAINTENANCE SUMMARY CHARTS.....	42

7.2. INSPECTION AND SERVICE INSTRUCTIONS	44
7.2.1. AXLE BOLTS, FRAME, SUSPENSION, & STRUCTURE	44
7.2.2. TRAILER STRUCTURE	44
7.2.3. DROP RAMP TORSION SPRINGS.....	45
7.2.4. SLIDE-OUTS	45
7.2.5. TRAILER BRAKES.....	45
7.2.6. TRAILER CONNECTION TO TOW VEHICLE	47
7.2.7. LANDING LEG OR JACK.....	47
7.2.8. LIGHTS AND SIGNALS	47
7.2.9. ACCESSORY BATTERY	48
7.2.10. TIRES.....	48
7.2.11. WHEEL RIMS.....	48
7.2.12. WHEELS, BEARINGS AND LUG NUTS	48
8. TANK-TRAILER INFORMATION	51
8.2 DIFFERENT FUEL TYPES USED IN TANKS	51
9. WARRANTY INFORMATION	52

1. GENERAL SAFETY INFORMATION

1.1. SAFETY ALERT SYMBOLS AND SIGNAL WORDS

An Owner's Manual that provides general trailer information cannot cover all the specific details necessary for the proper combination of every trailer, tow vehicle and hitch. Therefore, you must read, understand, and follow the instructions given by the tow vehicle and trailer hitch manufacturers, as well as the instructions in this manual.

Our trailers are built with components produced by various manufacturers. Some of these items have separate instruction manuals. Where this manual indicates that you should read another manual, and if you do not have that manual, call **Boss Trailers** at **903-703-9220** for a free copy.

The safety information in this manual is denoted by the safety alert symbol: ^
The level of risk is indicated by the following signal words.

^ DANGER
DANGER – Immediate hazards which WILL result in severe personal injury or death if the warning is ignored.

^ WARNING
WARNING – Hazards or unsafe practices which COULD result in severe personal injury or death if the warning is ignored.

^ Caution
CAUTION – Hazards or unsafe practices which could result in minor or moderate injury if the warning is ignored.

^ Notice
NOTICE – Practices that could result in damage to the trailer or other property.

1.2. MAJOR HAZARDS

Loss of control of the trailer or trailer/tow vehicle combination can result in death or serious injury. The most common causes for loss of control of the trailer are:

- Improper sizing the trailer for the tow vehicle, or vice versa.
- Excessive Speed: Driving too fast for the conditions.
- Failure to adjust driving behavior when towing a trailer.
- Overloading and/or improper weight distribution.
- Improper or mis-coupling of the trailer to the hitch.
- Improper braking and steering under sway conditions.
- Not maintaining proper tire pressure.
- Not keeping lug nuts tight.

1.2.1. IMPROPER SIZING OF THE TRAILER TO THE TOW VEHICLE

Trailers that weigh too much for the towing vehicle can cause stability problems, which can lead to death or serious injury. Furthermore, the additional strain put on the engine and drivetrain may lead to serious tow vehicle maintenance problems. For these reasons, the maximum towing capacity of your

towing vehicle should not be exceeded. The towing capacity of your tow vehicle, in terms of maximum Gross Trailer Weight (GTW) and maximum Gross Combined Weight Rating (GCWR) can be found in the tow vehicles Owner's Manual.

^ DANGER

Use of a hitch with a load rating less than the load rating of the trailer can result in loss of control and may lead to death or serious injury.

Use of a tow vehicle with a towing capacity less than the load rating of the trailer can result in loss of control and may lead to death or serious injury.

Be sure your hitch and tow vehicle are rated for the Gross Vehicle Weight Rating (GVWR) of your trailer.

1.2.2. DRIVING TOO FAST

With ideal road conditions, the maximum recommended speed for safely towing a trailer is 60 mph. If you drive too fast, the trailer is more likely to sway, thus increasing the possibility for loss of control. Also, your tires may overheat, thus increasing the possibility of a blowout.

^ WARNING

Driving too fast for conditions can result in loss of control and cause death or serious injury.

Decrease your speed as road, weather and lighting conditions deteriorate.

1.2.3. FAILURE TO ADJUST DRIVING BEHAVIOR WHEN TOWING A TRAILER

When towing a trailer, you will have decreased acceleration, increased stopping distance, and increased turning radius (which means you must make wider turns to keep from hitting curbs, vehicles, and anything else that is on the inside corner). Furthermore, the trailer will change the handling characteristics of your towing vehicle, making it more sensitive to steering inputs and more likely to be pushed around in windy conditions or when being passed by large vehicles. In addition, you will need a longer distance to pass, due to slower acceleration and increased length. With these caveats in mind:

Be alert for slippery conditions. You are more likely to be affected by slippery road surfaces when driving a tow vehicle with a trailer, than driving a tow vehicle without a trailer. Anticipate the trailer "swaying." Swaying can be caused by excessive steering, wind gusts, roadway edges, or by the trailer reaction to the pressure wave created by passing trucks and busses. When encountering trailer sway take your foot off the gas, and steer as little as possible to stay on the road. Use small "trim-like" steering adjustments. Do not attempt to steer out of the sway; you will only make it worse. Also do not apply the tow vehicle brakes to correct trailer swaying. On the other hand, application of the trailer brakes alone will tend to straighten out the combination, especially when going downhill. Check rearview mirrors frequently to observe the trailer and traffic. Use lower gear when driving down steep or long grades. Use the engine and transmission as a brake. Do not ride the brakes, as they can overheat and become ineffective. Be aware of your trailer height, especially when approaching bridges, roofed areas and around trees.

1.2.4. TRAILER NOT PROPERLY COUPLED TO THE HITCH

It is critical that the trailer be securely coupled to the hitch ball, and that the safety chains and emergency break-away brake cable are correctly attached. Uncoupling may result in death or serious injury to you and to others.

^ WARNING

Proper selection and condition of the coupler and hitch are essential to safely towing your trailer. A loss of coupling may result in death or serious injury.

- Be sure the hitch load rating is equal to or greater than the load rating of the coupler.
- Be sure the hitch size matches the coupler size.
- Observe the hitch for wear, corrosion, and cracks before coupling. Replace worn, corroded, or cracked hitch components before coupling the trailer to the tow vehicle.
- Be sure the hitch components are tight before coupling the trailer to the tow vehicle.

^ WARNING

An improperly coupled trailer can result in death or serious injury.

Do not move the trailer until:

- The coupler is secured and locked to hitch;
- The safety chains are secured to the tow vehicle; and
- The trailer jack(s) are fully retracted. Do not tow the trailer on the road until:
- Tires and wheels are checked;
- The trailer brakes are checked;
- The breakaway switch is connected to the tow vehicle;
- The load is secured to the trailer; and
- The trailer lights are connected and checked.

1.2.5. PROPER USE OF SAFETY CHAINS

If your trailer comes loose from the hitch for any reason, we have provided safety chains so that control of the trailer can still be maintained.

^ WARNING

Improper rigging of the safety chains can result in loss of control of the trailer and tow vehicle, leading to death or serious injury, if the trailer uncouples from the tow vehicle.

- Fasten chains to frame of tow vehicle. Do not fasten chains to any part of the hitch unless the hitch has holes or loops specifically for that purpose.
- Cross chains underneath hitch and coupler with enough slack to permit turning and to hold tongue up, if the trailer comes loose

1.2.6. PROPER CONNECTION OF BREAKAWAY BRAKE

If equipped with brakes your trailer will be equipped with a breakaway brake system that can apply the brakes on your trailer if your trailer comes loose from the hitch ball for any reason. You will have a separate set of instructions for the breakaway brake if your trailer is so equipped. The breakaway brake system, including battery, must be in good condition and properly rigged to be effective.

^ WARNING

An ineffective or inoperative breakaway brake system can result in a runaway trailer, leading to death or serious injury if the coupler or hitch fails.

The breakaway cable must be connected to the tow vehicle, and NOT to any part of the hitch.

Before towing the trailer, test the function of the breakaway brake system. If the breakaway brake system is not working, do not tow the trailer. Have it serviced or repaired.

1.2.7. MATCHING TRAILER AND HITCH

^ DANGER

Use of a hitch with a load rating less than the load rating of the trailer can result in loss of control and may lead to death or serious injury.

Use of a tow vehicle with a towing capacity less than the load rating of the trailer can result in loss of control and may lead to death or serious injury.

Be sure your hitch and tow vehicle are rated for the Gross Vehicle Weight Rating (GVWR) of your trailer.

1.2.8. WORN TIRES, LOOSE WHEELS, AND LUG NUTS

Just as with your tow vehicle the trailer tires and wheels are important safety items. Therefore, it is essential to inspect the trailer tires before each tow.

If a tire has a bald spot, bulge, cut, cracks, or is showing any cords, replace the tire before towing. If a tire has uneven tread wear, take the trailer to a dealer service center for diagnosis. Uneven tread wear can be caused by tire imbalance, axle misalignment or incorrect inflation.

Tires with too little tread will not provide adequate frictional forces on wet roadways and can result in loss of control, leading to death or serious injury.

Improper tire pressure causes increased tire wear and may reduce trailer stability, which can result in a tire blowout or possible loss of control. Therefore, before each tow you must also check the tire pressure. Remember, the proper tire pressure is listed on the Certification / VIN label, normally mounted on front left side of the trailer, and should be checked when tires are cold. Allow 3 hours cool-down after driving as much as 1 mile at 40 mph before checking tire pressure.

^ WARNING
Improper tire pressure can result in a blowout and loss of control, which can lead to death or serious injury. Be sure tires are inflated to pressure indicated on sidewall before towing trailer.

The tightness of the lug nuts is very important in keeping the wheels properly seated to the hub. Before each tow, check to make sure they are tight.

^ WARNING
Metal creep between the wheel rim and lug nuts will cause rim to loosen and could result in a wheel coming off, leading to death or serious injury. Tighten lug nuts before each tow.

The proper tightness (torque) for lug nuts is listed in Section 7.2.12.2 in the "Inspection and Service Instructions" chapter of this manual. Use a torque wrench to tighten the lug nuts, use the crisscross star pattern on page 50. If you do not have a torque wrench, use a lug wrench (from your tow vehicle), and tighten the nuts as much as you can. At the first opportunity, have a service garage or trailer dealer tighten the lug nuts to the proper torque.

Lug nuts are also prone to loosen after first being assembled. When driving a new trailer (or after wheels have been remounted), check to make sure they are tight after the **first** 10, 25 and 50 miles of driving and before each tow thereafter.

Failure to perform this check can result in a wheel separating from the trailer and a crash, leading to death or serious injury.

^ WARNING
Lug nuts are prone to loosen after initial installation, which can lead to death or serious injury. Check lug nuts for tightness on a new trailer or when wheel(s) have been remounted after the <u>first</u> 10, 25 and 50 miles of driving.

^ WARNING
Improper lug nut torque can cause a wheel separating from the trailer, leading to death or serious injury. Be sure lug nuts are tight before each tow.

1.2.9. IMPROPER LOADING

The total weight of the load you put in or on the trailer, plus the empty weight of the trailer itself, must not exceed the trailer's Gross Vehicle Weight Rating (GVWR). If you do not know the empty weight of the trailer plus the cargo weight, you must weigh the loaded trailer at a commercial scale. In addition, you must distribute the load in the trailer such that the load on any axle does not exceed the Gross Axle Weight Rating (GAWR). If your trailer is equipped with a Tire & Loading Information Placard, mounted next to the Certification / VIN label, the cargo capacity weight stated on that placard is only a close estimate. The GVWR and GAWR's are listed on the Certification / VIN label mounted on the front left side of the trailer.

^ WARNING
An overloaded trailer can result in loss of control of the trailer, leading to death or serious injury. Do not exceed the trailer Gross Vehicle Weight Rating (GVWR) or the Gross Axle Weight Rating (GAWR). Do not load a trailer so that the weight on any tire exceeds its rating.

1.2.10. UNSAFE LOAD DISTRIBUTION

Improper front / rear load distribution can lead to poor trailer sway stability or poor tow vehicle handling. Poor trailer sway stability results from tongue weights that are too low, and poor tow vehicle stability results from tongue weights that are too high. Refer to Chapter heading "Loading the Trailer" for more information.

In the table below, the second column shows the rule of thumb percentage of total weight of the trailer plus its cargo (Gross Trailer Weight, or "GTW") that should appear on the tongue of the trailer. For example, a trailer with a gooseneck hitch, with a loaded weight of 12,000 pounds, should have 20 - 25% of 12,000 pounds (2400-3000 lbs.) on the gooseneck. A dump trailer will have the proper weight distribution if the load is **evenly distributed** in the dump bed. For non-flowable (discrete) loads locate the load such as to provide the proper tongue weight.

After loading, be sure to check that none of the axles are overloaded.

Tongue Weight as a Percentage of Loaded Trailer Weight	
Type of Hitch	Percentage
Ball Hitch (or Bumper Hitch)	10-15% for large trailers
	6-10% for smaller utility and cargo trailers
	5-7% for boat trailers
Gooseneck Hitch	20-25%
Fifth Wheel Hitch	

The numbers quoted above are for example purposes only and should be tailored to the specific trailer. For questions regarding the actual percent of tongue weight for the trailer, check with the manufacturer for specifics.

Uneven left / right load distribution can cause tire, wheel, axle, or structural failure. Be sure your trailer is evenly loaded left / right. Towing stability also depends on keeping the center of gravity as low as possible.

^ WARNING
<p>Improper tongue weight (load distribution) can result in loss of control of the trailer, leading to death or serious injury.</p> <p>Make certain that tongue weight is within the allowable range.</p> <p>Be sure to:</p> <ul style="list-style-type: none"> • Distribute the load front-to-rear to provide proper tongue weight (see chart). • Distribute the load evenly, right, and left, to avoid tire overload; and • Keep the center of gravity low.

1.2.11. SHIFTING CARGO

Since the trailer "ride" can be bumpy and rough, you must secure your cargo so that it does not shift while the trailer is being towed.

^ WARNING
<p>Shifting cargo can result in loss of control of the trailer and can lead to death or serious injury.</p> <p>Tie down all loads with proper sized fasteners, ropes, straps, etc.</p>

If the door latch is equipped with a catch that has a hole for a linchpin, use a linchpin to prevent the door latch from opening.

^ WARNING

If the door opens, your cargo may be ejected onto the road, resulting in death or serious injury to other drivers.
Always secure the door latch after closing. Place a linchpin in the catch.

1.2.12. INAPPROPRIATE CARGO

Your trailer may be designed for specific cargo, for example, only for horses. If your trailer is designed for specific cargo, only carry that cargo in the trailer. A utility trailer must not be used to carry certain items, such as people, containers of hazardous substances or containers of flammable substances.

^ WARNING

Do not transport people inside the trailer, even if it has living quarters. The transport of people puts their lives at risk and may be illegal.

^ WARNING

Do not transport flammable, explosive, poisonous or other dangerous materials in your trailer.

1.2.13. INOPERABLE BRAKES, LIGHTS OR MIRRORS

Be sure that the electric brakes and all the lights on your trailer are functioning properly before towing your trailer. Electric brakes and lights on a trailer are controlled via a connection to the tow vehicle, generally a multi-pin electrical connector. Check the trailer tail lights by turning on your tow vehicle headlights. Check the trailer brake lights by having someone step on the tow vehicle brake pedal while you look at trailer lights. Do the same thing to check the turn signal lights.

If your trailer has electric brakes, your tow vehicle will have an electric brake controller that sends power to the trailer brakes. Before towing the trailer on the road, you must operate the brake controller while trying to pull the trailer to confirm that the electric brakes operate. While towing the trailer at less than 5 mph, manually operate the electric brake controller in the tow vehicle cab. You should feel the operation of the trailer brakes.

^ WARNING

Improper electrical connection between the tow vehicle and the trailer will result in inoperable lights and electric brakes and can lead to collision.

Before each tow:

- Check that the taillights, brake lights and turn signals work
- Check that the electric brakes work by operating the brake controller inside the tow vehicle

If your trailer has hydraulic "surge" brakes, pull the emergency break-away brake lanyard to check the operation of the surge mechanism.

Standard mirrors usually do not provide adequate visibility for viewing traffic to the sides and rear a towed trailer. You must provide mirrors that allow you to safely observe approaching traffic.

1.2.14. HAZARDS FROM MODIFYING YOUR TRAILER

Essential safety items can be damaged by altering your trailer. Even simply driving a nail or screw to hang something can damage an electrical circuit, LP gas line or other feature of the trailer.

Before making any alteration to your trailer, contact your dealer or **Boss Trailers** at **903-703-9220** and describe the alteration you are contemplating. Alteration of the trailer structure or modification of mechanical, electrical, plumbing, heating or other systems on your trailer must be performed only by qualified technicians who are familiar with the system as installed on your trailer.



⚠ WARNING

AVOID SERIOUS INJURY OR DEATH! LOADING OR UNLOADING TRAILER CAN BE DANGEROUS

- Be sure trailer is on level ground.
- Securely chock the wheels of the trailer.
- Ramps must be aligned properly and securely connected to trailer.
- Approach ramps slowly when loading or unloading.
- Do not allow others to stand near the loading area.

080010B

Trailers Equipped with Ramps

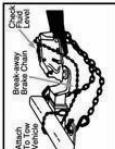
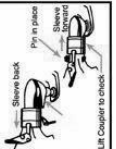
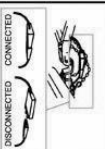
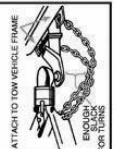
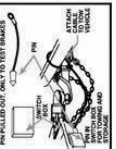
 <p>WARNING Unloading will cause trailer to come off hitch. To prevent this, you must:</p> <ol style="list-style-type: none"> CHECK that LOAD RATING is same as vehicle. CHECK that SIZE is same as coupler. CHECK that COUPLER CLAMP is on ball. LIFT coupler, check it is on ball, and not separate from ball. DO NOT TOW if lights are not working. 	 <p>WARNING Lights can prevent trailer from being towed. You must:</p> <ol style="list-style-type: none"> CONNECT trailer and tow vehicle electrical connectors. Turn on trailer lights, turn signal, and brake lights. DO NOT TOW if lights are not working. 	 <p>WARNING Always use safety chains. Cross chains underneath coupler. You must:</p> <ol style="list-style-type: none"> CROSS chains underneath coupler. ATTACH chain hooks securely to tow vehicle frame. 	 <p>WARNING Trailer can roll if it comes loose. Safety chains must be used. You must:</p> <ol style="list-style-type: none"> ATTACH safety chains to tow vehicle so lever will be pulled in case of failure. CHECK brake fluid level. DO NOT TOW trailer if brake fluid is NOT FULL.
 <p>WARNING Unloading will cause trailer to come off hitch. To prevent this, you must:</p> <ol style="list-style-type: none"> CHECK that LOAD RATING is same as vehicle. CHECK that SIZE is same as coupler. LIFT coupler, check it is on ball, and not separate from ball. DO NOT TOW if lights are not working. 	 <p>WARNING Lights can prevent trailer from being towed. You must:</p> <ol style="list-style-type: none"> CONNECT trailer and tow vehicle electrical connectors. Turn on trailer lights, turn signal, and brake lights. DO NOT TOW if lights are not working. 	 <p>WARNING Always use safety chains. Cross chains underneath coupler. You must:</p> <ol style="list-style-type: none"> CROSS chains underneath coupler. ATTACH chain hooks securely to tow vehicle frame. 	 <p>WARNING Trailer can roll if it comes loose. Safety chains must be used. You must:</p> <ol style="list-style-type: none"> ATTACH safety chains to tow vehicle so lever will be pulled in case of failure. CHECK brake fluid level. DO NOT TOW trailer if brake fluid is NOT FULL.

Trailer W/ Surge Brakes



Trailer W/ Electric Brakes

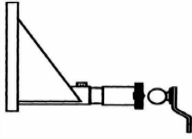
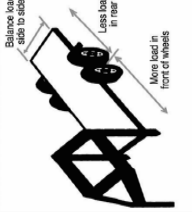
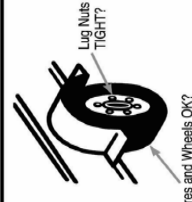
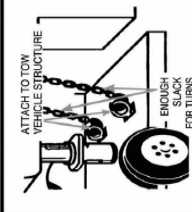
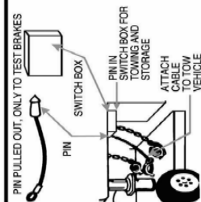
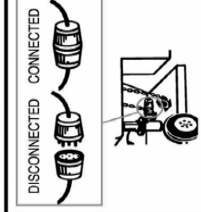

Bumper Pull Trailers – Left Side of Tongue

 <p>WARNING</p> <p>Uncoupling will cause trailer to come loose from tow vehicle. You must:</p> <ol style="list-style-type: none"> CHECK that ball LOAD RATING is same as or greater than coupler LOAD RATING. CHECK that ball SIZE is same as coupler. CLOSE COUPLER CLAMP on ball. LIFT coupler upwards to test that it will not separate from ball. LOCK coupler clamp with pin or padlock. 	 <p>WARNING</p> <p>Improper loading can cause trailer sway and sudden loss of control. You must:</p> <ul style="list-style-type: none"> Make certain weight of load plus trailer weight does not exceed trailer's capacity (GVWR-gross vehicle weight rating). Load heavier items in front of wheels. Load evenly side to side. SECURE load to trailer.
 <p>WARNING</p> <p>Tire, wheel or lugnut failure can cause loss of control. Before towing, you must CHECK:</p> <ol style="list-style-type: none"> Tire pressure and tread. Tires and wheels for damage. Lug nuts for tightness. <p>For new and remounted wheels, re-tighten lug nuts at the first 10, 25 and 50 miles of driving.</p>	 <p>WARNING</p> <p>ALWAYS use safety chains. Chains hold trailer if connection fails. You must:</p> <ol style="list-style-type: none"> ALLOW slack for trailer to turn. ATTACH chain hooks securely to tow vehicle frame.
 <p>WARNING</p> <p>ELECTRIC BRAKE MODELS</p> <p>Trailer can roll if it comes loose. Electric safety brake applies when cable pulls pin out of switch box.</p> <ol style="list-style-type: none"> PULL hard to get pin out of switch box. CHECK brake by PULLING TRAILER with tow vehicle. ATTACH pin CABLE to tow vehicle so pin will be pulled out if trailer separates. Promptly REPLACE pin in switch box. 	 <p>WARNING</p> <p>Lights can prevent trailer from being hit by other vehicles. You must:</p> <ol style="list-style-type: none"> CONNECT trailer and tow vehicle electrical connectors. CHECK all lights: tail lights, turn signal, and brake lights. DO NOT TOW if lights are not working.

Gooseneck Trailers – Left Side of Gooseneck Frame

WARNING

FIRE HAZARD

Do not place metal objects on top of Battery and Solenoid Terminals

All Trailers equipped with battery and/or hydraulic pump

WARNING

To protect you and others against death or serious injury, all the labels shown above must be on the trailer and must be legible.

If any of these labels are missing or cannot be read, call **Boss Trailers** at **903-703-9220** for free replacement labels.

You will need to provide us with the number shown at the bottom of the label(s) for us to send the correct one(s).

1.2.16. TRAILER TOWING GUIDE

Driving a vehicle with a trailer in tow is vastly different from driving the same vehicle without a trailer in tow. Acceleration, maneuverability, and braking are all diminished with a trailer in tow. It takes longer to get up to speed; you need more room to turn and pass, and more distance to stop when towing a trailer. You will need to spend time adjusting to the different feel and maneuverability of the tow vehicle with a loaded trailer. Because of the significant differences in all aspects of maneuverability when towing a trailer, the hazards and risks of injury are also much greater than when driving without a trailer. You are responsible for keeping your vehicle and trailer in control, and for all the damage that is caused if you lose control of your vehicle and trailer.

As you did when learning to drive an automobile, find an open area with little or no traffic for your first practice trailering. Of course, before you start towing the trailer, you must follow all the instructions for inspection, testing, loading, and coupling. Also, before you start towing, adjust the mirrors so you can see the trailer as well as the area to the rear of it.

Drive slowly at first, 5 mph or so, and turn the wheel to get the feel of how the tow vehicle and trailer combination responds. Next, make some right- and left-hand turns. Watch in your side mirrors to see how the trailer follows the tow vehicle. Turning with a trailer attached requires more room.

Stop the rig a few times from speeds no greater than 10 mph. If your trailer is equipped with brakes, try using different combinations of trailer/electric brake and tow vehicle brake. Note the effect that the trailer brakes have when they are the only brakes used. When properly adjusted, the trailer brakes will come on just before the tow vehicle brakes.

It will take practice to learn how to back up a tow vehicle with a trailer attached. Take it slow. Before backing up, get out of the tow vehicle and look behind the trailer to make sure that there are no obstacles. Some drivers place their hands at the bottom of the steering wheel, and while the tow vehicle is in reverse, "think" of the hands as being on the top of the wheel. When the hands move to the right (counter-clockwise, as you would do to turn the tow vehicle to the left when moving forward), the rear of the trailer moves to the right. Conversely, rotating the steering wheel clockwise with your hands at the bottom of the wheel will move the rear of the trailer to the left, while backing up. If you are towing a bumper hitch rig, be careful not to allow the trailer to turn too much, because it will hit the rear of the tow vehicle. To straighten the rig, either pull forward, or turn the steering wheel in the opposite direction.

1.2.17. REPORTING SAFETY DEFECTS

If you believe that your vehicle has a defect that could cause a crash or could cause injury or death, you should immediately inform the National Highway Traffic Safety Administration (NHTSA) in addition to notifying **Boss Trailers**.

If NHTSA receives similar complaints, it may open an investigation, and if it finds that a safety defect exists in a group of vehicles, it may order a recall and remedy campaign. However, NHTSA cannot become involved in individual problems between you, your dealer, or **Boss Trailers**.

To contact NHTSA, you may either call the Vehicle Safety Hotline toll-free at 1-888-327-4236 (TTY: 1-800-424-9153), go to <http://www.safercar.gov>; or write to: Administrator, NHTSA, 1200 New Jersey Ave. SE., Washington, DC 20590. You can also obtain other information about motor vehicle safety from <http://www.safercar.gov>.

Call **903-703-9220** to reach **Boss Trailers**.

1.3. SAFE TRAILER TOWING GUIDELINES

Recheck the load tiedowns to make sure the load will not shift during towing. Before towing, check coupling, safety chain, safety brake, tires, wheels, and lights. Check the lug nuts or bolts for tightness. Check coupler tightness after towing 50 miles. Adjust the brake controller to engage the trailer brakes before the tow vehicle brakes. Follow the instructions given with the brake controller manufacturer's literature. Use your mirrors to verify that you have room to change lanes or pull into traffic. Use your turn signals well in advance. Allow plenty of stopping space for your trailer and tow vehicle. Do not drive so fast that the trailer begins to sway due to speed. Generally, never drive faster than 60 m.p.h. Allow plenty of room for passing. A rule of thumb is that the passing distance with a trailer is 4 times the passing distance without a trailer. Shift your automatic transmission into a lower gear for city driving. Use lower gears for climbing and descending grades. Do not ride the brakes while descending grades, they may get so hot that they stop working. Then you will potentially have a runaway tow vehicle and trailer. To conserve fuel, do not use full throttle to climb a hill. Instead, build speed on the approach. Slow down for bumps in the road. Take your foot off the brake when crossing the bump. Do not brake while in a curve unless absolutely necessary. Instead, slow down before you enter the curve. Do not apply the tow vehicle brakes to correct extreme trailer swaying. Instead, lightly apply the trailer brakes with the hand controller. Make regular stops, about once each hour. Confirm that the coupler is secure to the hitch and is locked, electrical connectors are made, there is appropriate slack in the safety chains, there is appropriate slack in the breakaway switch pull pin cable, the tires are not visibly low on pressure, and the cargo is secure and in good condition.

2. TIRE SAFETY INFORMATION

This portion of the User's Manual contains tire safety information as required by 49 CFR 575.6.

Section 2.1 contains "Steps for Determining Correct Load Limit - Trailer".

Section 2.2 contains "Steps for Determining Correct Load Limit – Tow Vehicle".

Section 2.3 contains a Glossary of Tire Terminology, including "cold inflation pressure", "maximum inflation pressure", "recommended inflation pressure", and other non-technical terms.

Section 2.4 contains information from the NHTSA brochure entitled "Tire Safety – Everything Rides on It". This brochure describes the following items:

- Tire labeling, including a description and explanation of each marking on the tires, and information about the DOT Tire Identification Number (TIN).
- Recommended tire inflation pressure, including a description and explanation of:
 - A. Cold inflation pressure.
 - B. Vehicle Placard and location on the vehicle.
 - C. Adverse safety consequences of under inflation (including tire failure).
 - D. Measuring and adjusting air pressure for proper inflation.
- Tire Care, including maintenance and safety practices.
- Vehicle load limits, including a description and explanation of the following items:
 - a. Locating and understanding the load limit information, total load capacity, and cargo capacity.
 - b. Calculating total and cargo capacities with varying seating configurations including quantitative examples showing / illustrating how the vehicles cargo and luggage capacity decreases as combined number and size of occupants' increases. This item is also discussed in Section 3.
 - c. Determining compatibility of tire and vehicle load capabilities.
 - d. Adverse safety consequences of overloading on handling and stopping on tires.

2.1. STEPS FOR DETERMINING CORRECT LOAD LIMIT – TRAILER

2.1.1. TRAILERS 10,000 POUNDS GVWR OR LESS

1. Locate the statement, "The weight of cargo should never exceed XXX kg or XXX lbs.," on your vehicle's placard. See figure 1-1.
2. This figure equals the available amount of cargo and luggage load capacity.
3. Determine the combined weight of luggage and cargo being loaded on the vehicle. That weight may not safely exceed the available cargo and luggage load capacity.

The trailer's placard refers to the Tire Information Placard attached adjacent to or near the trailer's VIN (Certification) label at the left front of the trailer. Note: The following calculations in Sections 2.1.2 and 2.2 are not required by the government. For completeness, NATM has included these statements.

2.1.2. TRAILERS OVER 10,000 POUNDS GVWR

(NOTE: THESE TRAILERS ARE NOT REQUIRED TO HAVE A TIRE INFORMATION PLACARD ON THE TRAILER AND MAY NOT HAVE ONE INSTALLED)

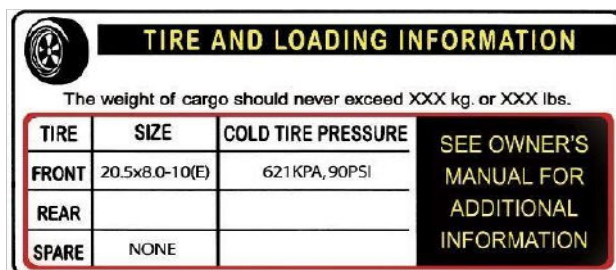

The placard features a tire icon in the top left corner. The title "TIRE AND LOADING INFORMATION" is centered at the top in yellow text on a black background. Below the title, a warning statement reads: "The weight of cargo should never exceed XXX kg. or XXX lbs." The main body of the placard is a table with three columns: "TIRE", "SIZE", and "COLD TIRE PRESSURE". The "FRONT" row shows "20.5x8.0-10(E)" and "621 KPA, 90PSI". The "REAR" row is empty. The "SPARE" row shows "NONE". To the right of the table, a black box with white text says "SEE OWNER'S MANUAL FOR ADDITIONAL INFORMATION".

TIRE	SIZE	COLD TIRE PRESSURE
FRONT	20.5x8.0-10(E)	621 KPA, 90PSI
REAR		
SPARE	NONE	

Tire and Loading Information Placard – Figure 1-1

1. Determine the empty weight of your trailer by weighing the trailer using a public scale or other means. This step does not have to be repeated.
2. Locate the GVWR (Gross Vehicle Weight Rating) of the trailer on your trailer's VIN (Certification) label.
3. Subtract the empty weight of your trailer from the GVWR stated on the VIN label. That weight is the maximum available cargo capacity of the trailer and may not be safely exceeded.

2.2. STEPS FOR DETERMINING CORRECT LOAD LIMIT – TOW VEHICLE

1. Locate the statement, "The combined weight of occupants and cargo should never exceed XXX lbs." on your vehicle's placard.
2. Determine the combined weight of the driver and passengers who will be riding in your vehicle.
3. Subtract the combined weight of the driver and passengers from XXX kilograms or XXX pounds.
4. The resulting figure equals the available amount of cargo and luggage capacity. For example, if the "XXX" amount equals 1400 lbs. and there will be five 150 lb. passengers in your vehicle, the amount of available cargo and luggage capacity is 650 lbs. (1400-750 (5 x 150) = 650 lbs.).
5. Determine the combined weight of luggage and cargo being loaded on the vehicle. That weight may not safely exceed the available cargo and luggage capacity calculated in Step #4.
6. If your vehicle will be towing a trailer, load from your trailer will be transferred to your vehicle. Consult the tow vehicle's manual to determine how this weight transfer reduces the available cargo and luggage capacity of your vehicle.

2.3. TIRE SAFETY - EVERYTHING RIDES ON IT

The National Traffic Safety Administration (NHTSA) has published a brochure (DOT HS 809 361) that discusses all aspects of Tire Safety, as required by CFR 575.6. This brochure is reproduced in part below. It can be obtained and downloaded from NHTSA, free of charge, from the following web site:

http://www.nhtsa.dot.gov/cars/rules/TireSafety/ridesonit/tires_index.html

Studies of tire safety show that maintaining proper tire pressure, observing tire and vehicle load limits (not carrying more weight in your vehicle than your tires or vehicle can safely handle), avoiding road hazards, and inspecting tires for cuts, slashes, and other irregularities are the most important things you can do to avoid tire failure, such as tread separation or blowout and flat tires. These actions, along with other care and maintenance activities, can also:

- Improve vehicle handling
- Help protect you and others from avoidable breakdowns and accidents
- Improve fuel economy
- Increase the life of your tires.

This booklet presents a comprehensive overview of tire safety, including information on the following topics:

- Basic tire maintenance
- Uniform Tire Quality Grading System
- Fundamental characteristics of tires
- Tire safety tips.

Use this information to make tire safety a regular part of your vehicle maintenance routine. Recognize that the time you spend is minimal compared with the inconvenience and safety consequences of a flat tire or other tire failure.

2.3.1. SAFETY FIRST–BASIC TIRE MAINTENANCE

Properly maintained tires improve the steering, stopping, traction, and load-carrying capability of your vehicle. Underinflated tires and overloaded vehicles are a major cause of tire failure. Therefore, as mentioned above, to avoid flat tires and other types of tire failure, you should maintain proper tire pressure, observe tire and vehicle load limits, avoid road hazards, and regularly inspect your tires.

2.3.2. FINDING YOUR VEHICLE'S RECOMMENDED TIRE PRESSURE AND LOAD LIMITS

Tire information placards and vehicle certification labels contain information on tires and load limits. These labels indicate the vehicle manufacturer's information including:

- Recommended tire size
- Recommended tire inflation pressure
- Vehicle capacity weight (VCW–the maximum occupant and cargo weight a vehicle is designed to carry)
- Front and rear gross axle weight ratings (GAWR– the maximum weight the axle systems are designed to carry)

Both placards and certification labels are permanently attached to the trailer near the left front.

2.3.3. UNDERSTANDING TIRE PRESSURE AND LOAD LIMITS

Tire inflation pressure is the level of air in the tire that provides it with load-carrying capacity and affects the overall performance of the vehicle. The tire inflation pressure is a number that indicates the amount of air pressure– measured in pounds per square inch (psi)—a tire requires to be properly inflated. (You will also find this number on the vehicle information placard expressed in kilopascals (kPa), which is the metric measure used internationally.) Manufacturers of passenger vehicles and light trucks determine this number based on the vehicle's design load limit, that is, the greatest amount of weight a vehicle can safely carry and the vehicle's tire size. The proper tire pressure for your vehicle is referred to as the "recommended cold inflation pressure." (As you will read below, it is difficult to obtain the recommended tire pressure if your tires are not cold.) Because tires are designed to be used on more than one type of vehicle, tire manufacturers list the "maximum permissible inflation pressure" on the tire sidewall. This number is the greatest amount of air pressure that should ever be put in the tire under normal driving conditions.

2.3.4. CHECKING TIRE PRESSURE

It is important to check your vehicle's tire pressure at least once a month for the following reasons:

- Most tires may naturally lose air over time.
- Tires can lose air suddenly if you drive over a pothole or other object or if you strike the curb when parking.
- With radial tires, it is usually not possible to determine underinflation by visual inspection.

For convenience, purchase a tire pressure gauge to keep in your vehicle. Gauges can be purchased at tire dealerships, auto supply stores, and other retail outlets. The recommended tire inflation pressure that vehicle manufacturers provide reflects the proper psi when a tire is cold. The term cold does not relate to the outside temperature. Rather, a cold tire is one that has not been driven on for at least three hours. When you drive, your tires get warmer, causing the air pressure within them to increase. Therefore, to get an accurate tire pressure reading, you must measure tire pressure when the tires are cold or compensate for the extra pressure in warm tires.

2.3.5. STEPS FOR MAINTAINING PROPER TIRE PRESSURE

- Step 1: Locate the recommended tire pressure on the vehicle's tire information placard, certification label, or in the owner's manual.
- Step 2: Record the tire pressure of all tires.
- Step 3: If the tire pressure is too high in any of the tires, slowly release air by gently pressing on the tire valve stem with the edge of your tire gauge until you get to the correct pressure.
- Step 4: If the tire pressure is too low, note the difference between the measured tire pressure and the correct tire pressure. These "missing" pounds of pressure are what you will need to add.
- Step 5: At a service station, add the missing pounds of air pressure to each tire that is underinflated.
- Step 6: Check all the tires to make sure they have the same air pressure (except in cases in which the front and rear tires are supposed to have different amounts of pressure).

If you have been driving your vehicle and think that a tire is underinflated, fill it to the recommended cold inflation pressure indicated on your vehicle's tire information placard or certification label. While your tire may still be slightly underinflated due to the extra pounds of pressure in the warm tire, it is safer to drive with air pressure that is slightly lower than the vehicle manufacturer's recommended cold inflation pressure than to drive with a significantly underinflated tire. Since this is a temporary fix, do not forget to recheck and adjust the tire's pressure when you can obtain a cold reading.

2.3.6. TIRE SIZE

To maintain tire safety, purchase new tires that are the same size as the vehicle's original tires, or another size recommended by the manufacturer. Look at the tire information placard, the owner's manual, or the sidewall of the tire you are replacing to find this information. If you have any doubt about the correct size to choose, consult with the tire dealer.

2.3.7. TIRE TREAD

The tire tread provides the gripping action and traction that prevent your vehicle from slipping or sliding, especially when the road is wet or icy. In general, tires are not safe and should be replaced when the tread is worn down to 1/16 of an inch. Tires have built-in treadwear indicators that let you know when it is time to replace your tires. These indicators are raised sections spaced intermittently in the bottom of the tread grooves. When they appear "even" with the outside of the tread, it is time to replace your tires. Another method for checking tread depth is to place a penny in the tread with Lincoln's head upside down and facing you. If you can see the top of Lincoln's head, you are ready for new tires.

2.3.8. TIRE BALANCE AND WHEEL ALIGNMENT

To avoid vibration or shaking of the vehicle when a tire rotates, the tire must be properly balanced. This balance is achieved by positioning weights on the wheel to counterbalance heavy spots on the wheel-and-tire assembly. A wheel alignment adjusts the angles of the wheels so that they are positioned correctly relative to the vehicle's frame. This adjustment maximizes the life of your tires. These adjustments require special equipment and should be performed by a qualified technician.

2.3.9. TIRE REPAIR

The proper repair of a punctured tire requires a plug for the hole and a patch for the area inside the tire that surrounds the puncture hole. Punctures through the tread can be repaired if they are not too large, but punctures to the sidewall should not be repaired. Tires must be removed from the rim to be properly inspected before being plugged and patched.

2.3.10. TIRE FUNDAMENTALS

Federal law requires tire manufacturers to place standardized information on the sidewall of all tires. This information identifies and describes the fundamental characteristics of the tire and provides a tire identification number for safety standard certification and in case of a recall.

2.3.10.1. INFORMATION ON PASSENGER VEHICLE TIRES

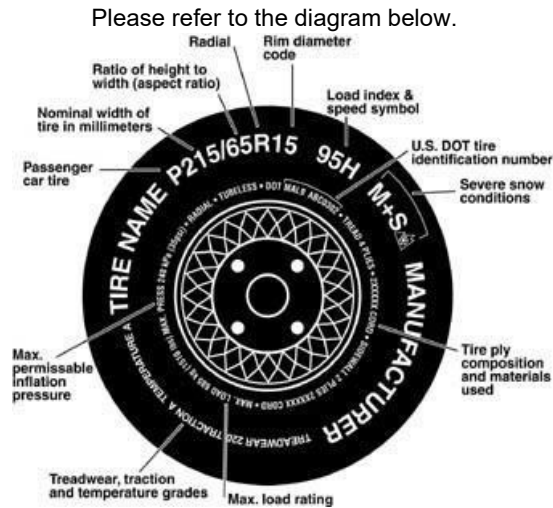

P

The "P" indicates the tire is for passenger vehicles.

Next number

This three-digit number gives the width in millimeters of the tire from sidewall edge to sidewall edge. In general, the larger the number, the wider the tire.

Next number

This two-digit number, known as the aspect ratio, gives the tire's ratio of height to width. Numbers of 70 or lower indicate a short sidewall for improved steering response and better overall handling on dry pavement.

R

The "R" stands for radial. Radial ply construction of tires has been the industry standard for the past 20 years.

Next number

This two-digit number is the wheel or rim diameter in inches. If you change your wheel size, you will have to purchase new tires to match the new wheel diameter.

Next number

This two- or three-digit number is the tire's load index. It is a measurement of how much weight each tire can support. You may find this information in your owner's manual. If not, contact a local tire dealer. Note: You may not find this information on all tires because it is not required by law.

M+S

The "M+S" or "M/S" indicates that the tire has some mud and snow capability. Most radial tires have these markings; hence, they have some mud and snow capability.

Speed Rating

The speed rating denotes the speed at which a tire is designed to be driven for extended periods of time. The ratings range from 99 miles per hour (mph) to 186 mph. These ratings are listed below. Note: You may not find this information on all tires because it is not required by law.

Letter Rating Speed Rating Q 99 mph R 106 mph S 112 mph T 118 mph U 124 mph H 130 mph V 149 mph W 168* mph Y 186* mph

* For tires with a maximum speed capability over 149 mph, tire manufacturers sometimes use the letters ZR. For those with a maximum speed capability over 186 mph, tire manufacturers always use the letters ZR.

U.S. DOT Tire Identification Number

This begins with the letters "DOT" and indicates that the tire meets all federal standards. The next two numbers or letters are the plant code where it was manufactured, and the last four numbers represent the week and year the tire was built. For example, the numbers 3197 mean the 31st week of 1997.

The other numbers are marketing codes used at the manufacturer's discretion. This information is used to contact consumers if a tire defect requires a recall.

Tire Ply Composition and Materials Used

The number of plies indicates the number of layers of rubber-coated fabric in the tire. In general, the greater the number of plies, the more weight a tire can support. Tire manufacturers also must indicate the materials in the tire, which include steel, nylon, polyester, and others.

Maximum Load Rating

This number indicates the maximum load in kilograms and pounds that can be carried by the tire.

Maximum Permissible Inflation Pressure

This number is the greatest amount of air pressure that should ever be put in the tire under normal driving conditions.

2.3.10.2. UTQGS INFORMATION

Treadwear Number

This number indicates the tire's wear rate. The higher the treadwear number is, the longer it should take for the tread to wear down. For example, a tire graded 400 should last twice as long as a tire graded 200.

Traction Letter

This letter indicates a tire's ability to stop on wet pavement. A higher graded tire should allow you to stop your car on wet roads in a shorter distance than a tire with a lower grade. Traction is graded from highest to lowest as "AA", "A", "B", and "C".

Temperature Letter

This letter indicates a tire's resistance to heat. The temperature grade is for a tire that is inflated properly and not overloaded. Excessive speed, underinflation or excessive loading, either separately or in combination, can cause heat build-up and possible tire failure. From highest to lowest, a tire's resistance to heat is graded as "A", "B", or "C".

2.3.10.3. ADDITIONAL INFORMATION ON LIGHT TRUCK TIRES

Please refer to the following diagram.

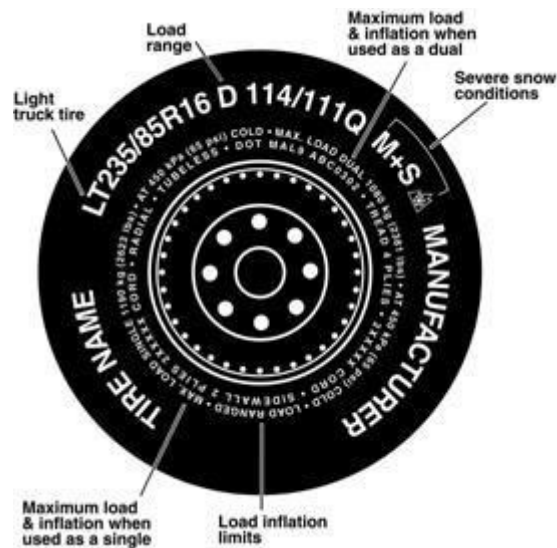

Tires for light trucks have other markings besides those found on the sidewalls of passenger tires.

LT

The "LT" indicates the tire is for light trucks or trailers.

ST

An "ST" is an indication the tire is for trailer use only.

Max. Load Dual kg (lbs) at kPa (psi) Cold

This information indicates the maximum load and tire pressure when the tire is used as a dual, that is, when four tires are put on each rear axle (a total of six or more tires on the vehicle).

Max. Load Single kg (lbs) at kPa (psi) Cold

This information indicates the maximum load and tire pressure when the tire is used as a single.

Load Range: This information identifies the tire's load-carrying capabilities and its inflation limits.

2.3.11. TIRE SAFETY TIPS

Preventing Tire Damage

- Slow down if you must go over a pothole or other object in the road.
- Do not run over curbs or other foreign objects in the roadway and try not to strike the curb when parking.

Tire Safety Checklist

- Check tire pressure regularly (at least once a month), including the spare.
- Inspect tires for uneven wear patterns on the tread, cracks, foreign objects, or other signs of wear or trauma.
- Remove bits of glass and foreign objects wedged in the tread.
- Make sure your tire valves have valve caps.
- Check tire pressure before going on a long trip.
- Do not overload your vehicle. Check the Tire Information and Loading Placard or User's Manual for the maximum recommended load for the vehicle.

3. COUPLING TO THE TOW VEHICLE

Follow all the safety precautions and instructions in this manual to ensure safety of persons, cargo, and satisfactory life of the trailer.

3.1. USE AN ADEQUATE TOW VEHICLE AND HITCH

If the vehicle or hitch is not properly selected and matched to the Gross Vehicle Weight Rating (GVWR) of your trailer, you can cause an accident that could lead to death or serious injury. If you already have a tow vehicle, know your vehicle tow rating, and Gross Combination Weight Rating (GCWR) and make certain the trailer's rated capacity is less than or equal to the tow vehicle's rated towing capacity. If you already have (or plan to buy) a trailer, make certain that the tow rating of the tow vehicle is equal to or greater than the GVWR of the trailer, and that the GCWR will be within limits.

^ DANGER

Use of a hitch with a load rating less than the load rating of the trailer can result in loss of control and may lead to death or serious injury.

Use of a tow vehicle with a towing capacity less than the load rating of the trailer can result in loss of control and may lead to death or serious injury.

Be sure your hitch and tow vehicle are rated for the Gross Vehicle Weight Rating (GVWR) of your trailer.

3.2. TRAILER INFORMATION / CERTIFICATION / VIN LABEL

Certification / VIN Tag Location

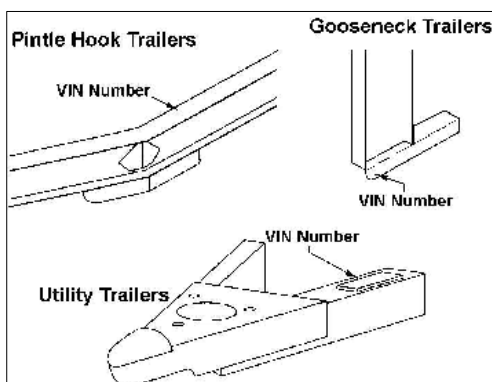

Certification VIN / Tag Preview

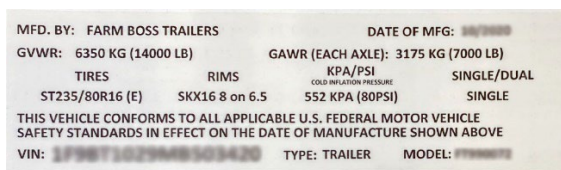

3.2.1.1. CERTIFICATION / VIN TAG

Vin Tag contains the following critical safety information for the use of your trailer:

MANUFACTURER: Name of trailer manufacturer.

DATE OF MANUFACTURE: Month and year the trailer was manufactured.

GVWR: The Gross Vehicle Weight Rating is the maximum allowable gross weight of the trailer and its contents. The gross weight of the trailer includes the weight of the trailer and all the items within it (such as cargo, water, food, and other supplies).

GAWR: The Gross Axle Weight Rating is the maximum gross weight that an axle can support. It is the lowest of axle, wheel, or tire rating. Sometimes the tire or wheel rating is lower than the axle manufacturers rating and will then determine GAWR. The total of the GAWR for all trailer axles may be less than the GVWR for the trailer because some of the trailer load is carried by the tow vehicle, rather than by the trailer axle(s). The total weight of the cargo and trailer must not exceed the GVWR, and the load on an axle must not exceed its GAWR.

TIRE SIZE: The tire size recommended for your trailer and load range.

PSIC: The “pounds per square inch- cold” is the tire pressure (Kilopascals / Pounds per Square Inch) measured when Cold.

CERTIFICATION STATEMENT: “This trailer meets all the Federal Motor Vehicle Safety Standards in effect on the date of manufacture shown above”.

VIN: The Vehicle Identification Number.

VEHICLE TYPE: Generally, the word “trailer” is used. However, after this you may put a Model #, or additional descriptor.

3.2.1.2. DEFINITIONS

Tow Vehicle: When equipping a new vehicle or an older vehicle to tow your trailer, ask the vehicle dealer for advice on how to outfit the towing vehicle. Discuss the following information and equipment with the vehicle dealer.

Overall Carrying and Towing Capacity of Vehicle: Vehicle manufacturers will provide you with the maximum towing capacities of their various models, as well as the GCWR. No amount of reinforcement will give a 100 horsepower, 2,500 pound truck the towing capacity that a 300 horsepower, 5,000 pound truck has.

Towing Hitch: The towing hitch attached to your tow vehicle must have a capacity equal to or greater than the load rating of the trailer you intend to tow. The hitch capacity must also be matched to the tow vehicle capacity.

Suspension System: A tow vehicle equipped with a factory installed “Towing Package” likely comes equipped with heavy duty springs, heavy duty tires and other suspension components which are able to serve the size and weight of the trailer that the vehicle is rated to tow. However, the addition of additional equipment may further improve the tow vehicle performance. These may include adjustable air shocks, helper springs, etc.

Brake Controller: The brake controller is part of the tow vehicle and is essential in the operation of the electric brakes on the trailer. If your trailer has electric brakes it requires a brake controller be installed at the driver’s position. The brake controller is not the same as the safety breakaway brake system that is installed on the trailer.

Side View Mirrors: The size of the trailer that is being towed and your state law regulations determine the size of the mirrors. However, some states prohibit extended mirrors on a tow vehicle, except while a trailer is being towed. In this situation, detachable extended mirrors are necessary. Check with your dealer or the appropriate state agency for mirror requirements.

Heavy Duty Flasher: A Heavy-Duty Flasher is an electrical component that may be required when your trailer turn signal lights are attached to the tow vehicle flasher circuit.

Electrical Connector: An Electrical Connector connects the light and brake systems on the trailer to the light and brake controls on the towing vehicle.

Heavy Duty Engine Oil Cooling System: The tow vehicle engine works harder when a trailer is being towed. Depending on the size of the trailer, you may need to install a separate engine oil cooler. Inadequate cooling may result in sudden engine failure. Ask the tow vehicle dealer if it is necessary to install a heavy-duty cooling system.

Automatic Transmission Oil Cooler: The automatic transmission of a towing vehicle handles more power when a trailer is being towed. Inadequate cooling will shorten transmission life and may result in sudden transmission failure. Ask the tow vehicle dealer if it is necessary to install a separate oil cooler for the automatic transmission.

Fire Extinguisher: It is sensible to have a fire extinguisher in the tow vehicle.

Emergency Flares and Emergency Triangle Reflectors: It is wise to carry these warning devices even if you are not towing a trailer. It is particularly important to have these when towing a trailer because the hazard flashers of your towing vehicle will not operate for as long a period of time when the battery is running both the trailer lights and tow vehicle lights.

3.3. COUPLING AND UNCOUPLING THE TRAILER

A secure coupling (or fastening) of the trailer to the tow vehicle is essential. A loss of coupling may result in death or serious injury. Therefore, you must understand and follow all the instructions for coupling.

The following parts are involved in making a secure coupling between the trailer and tow vehicle:

Coupling: That part of the trailer connecting mechanism by which the connection is actually made to the trailer hitch. This does not include any structural member, extension of the trailer frame, or brake controller.

Hitch: That part of the connecting mechanism including the ball support platform and ball and those components that extend and are attached to the towing vehicle, including bumpers intended to serve as hitches.)

Weight Distributing Hitch (or Equalizing Hitch): A mechanical device that connects the trailer to the towing vehicle and by means of leverage applied on both the trailer and towing vehicle structures, when properly adjusted, distributes the imposed vertical load at the hitch and coupling connection between structures of the towing vehicle and trailer.

Weight Carrying Hitch: A mechanical and/or structural device that connects the trailer to the towing vehicle and that does not employ features designed to redistribute the load imposed at the hitch and carrying connection.

Safety chains or cables: Chains or cables permanently attached to the trailer such that if the coupler connection comes loose, the safety chains or cables can keep the trailer attached to the tow vehicle. With properly rigged safety chains or cables, it is possible to keep the tongue of the trailer from digging into the road pavement, even if the coupler-to-hitch connection comes apart. Some states do not allow safety cables, e.g. Pennsylvania; therefore it may be wise to check with the State Police to see if your state has any restrictions on the use of safety cables, if your trailer is so equipped.

Trailer lighting (and braking) connector: A device that connects electrical power from the tow vehicle to the trailer. Electricity is used to turn on brake lights, running lights, and turn signals as required. In addition, if your trailer has a separate braking system, the electrical connector will also supply power to the trailer brakes from the tow vehicle.

Breakaway switch: If the trailer becomes de-coupled from the towing vehicle, the breakaway switch lanyard, attached independently to the tow vehicle hitch, will pull a pin in the emergency electrical break-away switch on the trailer. The breakaway switch is activated by a separate battery supply in the trailer such as to energize the trailer brakes independently of the towing vehicle. It is important to check the state of charge of the emergency breakaway battery before each trip. Simply pull the pin out of the switch by hand and then try to pull the trailer. If you feel a significant drag force the brakes are activated. Be sure to re-insert the pin in the break-away switch. Also be sure to allow enough slack in the break-away brake lanyard such that the switch will only activate (pin pulls out) if the coupler connection comes loose. For additional details refer to Section 0

Jack: A device on the trailer that is used to raise and lower the trailer tongue. On larger trailers the jack is sometimes called the "landing gear."

^ WARNING
<p>An improperly coupled trailer can result in death or serious injury.</p> <p>Do not move the trailer until:</p> <ul style="list-style-type: none">• The coupler is secured and locked to hitch;• The safety chains are secured to the tow vehicle; and• The trailer jack(s) are fully retracted. <p>Do not tow the trailer on the road until:</p> <ul style="list-style-type: none">• Tires and wheels are checked;• The trailer brakes are checked;• The breakaway switch is connected to the tow vehicle;• The load is secured to the trailer; and• The trailer lights are connected and checked.

3.3.1. VARIOUS COUPLER DESIGNS

Trailers are produced with a variety of coupler devices. One of the sections below will pertain to your trailer.

- Bumper pull (Ball Hitch) Coupler
- Gooseneck Hitch Coupler
- Fifth Wheel Coupler

If the coupler on your trailer does not resemble one of the couplers shown in the figures, see the separate coupler instructions. If you do not have separate coupler instructions, call **Boss Trailers** at **903-703-9220** for a free copy.

3.3.2. TRAILER WITH BALL-HITCH COUPLER

A ball hitch coupler connects to a ball that is located on or under the rear bumper of tow vehicle. This system of coupling a trailer to a tow vehicle is sometimes referred to as "bumper pull."

A ball hitch trailer may be fitted with a tongue jack that can raise and lower the coupler. The tongue jack is mounted to the A-frame (front, or tongue) part of the trailer. By rotating the jack handle clockwise, the jack will extend and raise the tongue of the trailer.

Trailer with Ball Hitch Coupler

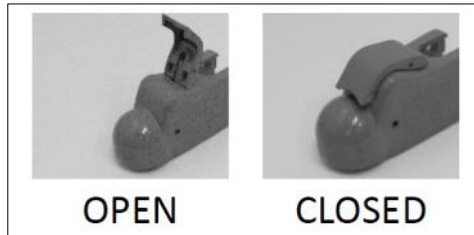

Be sure the Ball Hitch coupler is suitable for the size and weight of the trailer. The load rating of the coupler and the necessary ball size are listed on the trailer tongue. You must provide a hitch and ball for your tow vehicle, where the load rating of the hitch and ball is equal to or greater than that of your trailer. Also, the ball size must be the same as the coupler size. If the hitch ball is too small, too large, is underrated, is loose or is worn, the trailer can come loose from the tow vehicle, and may cause death or serious injury.

THE TOW VEHICLE, HITCH AND BALL MUST HAVE A RATED TOWING CAPACITY EQUAL TO OR GREATER THAN THE TRAILER GROSS VEHICLE WEIGHT RATING (GVWR).

IT IS ESSENTIAL THAT THE HITCH BALL BE OF THE SAME SIZE AS THE COUPLER.

The ball size and load rating (capacity) are marked on the ball; hitch capacity is marked on the hitch.

3.3.2.1. BEFORE COUPLING THE TRAILER TO THE TOW VEHICLE

Be sure the size and rating of hitch ball match the size and rating of the coupler. Hitch balls and couplers are marked with their size and rating.

^ WARNING
<p>Coupler-to-hitch mismatch can result in uncoupling, leading to death or serious injury.</p> <p>Be sure the LOAD RATING of the hitch ball is equal or greater than the load rating of the coupler.</p> <p>Be sure the SIZE of the hitch ball matches the size of the coupler.</p>

Wipe the hitch ball clean and inspect it visually and by feel for flat spots, cracks, and pits.

^ WARNING
<p>A worn, cracked, or corroded hitch ball can fail while towing, and may result in death or serious injury.</p> <p>Before coupling trailer, inspect the hitch ball for wear, corrosion, and cracks.</p> <p>Replace worn or damaged hitch ball.</p>

Rock the ball to make sure it is tight to the hitch, and visually check that the hitch ball nut is solid against the lock washer and hitch frame.

Wipe the inside and outside of the coupler clean and inspect it visually for cracks and deformations; feel the inside of the coupler for worn spots and pits.

Be sure the coupler is tight to the tongue of the trailer. All coupler fasteners must be visibly solid against the trailer frame.

^ WARNING
<p>A loose hitch ball nut can result in uncoupling, leading to death or serious injury.</p> <p>Be sure the hitch ball is tight to the hitch before coupling the trailer.</p>

Raise the bottom surface of the coupler to be above the top of the hitch ball. Use the jack if one is provided; otherwise, use wood or concrete blocks to support the trailer tongue. Prepare the coupler and hitch. Lubricate the hitch ball and the inside of the coupler with a thin layer of automotive bearing grease. If your trailer is equipped with a jack, raise the coupler above the ball height.

Open the coupler locking mechanism. Ball couplers have a locking mechanism with an internal moving piece (ball clamp) and an outside handle, wheel, or latch.

In the open position, the coupler is able to drop fully onto the hitch ball. See the coupler instructions for details of placing the coupler in the "open" position.

Slowly back up the tow vehicle so that the hitch ball is near or aligned under the coupler if the trailer jack has raised the coupler.

Couple the trailer to the tow vehicle

If your trailer does not have a jack, you will have to lift the coupler and place it over the ball.

If you have a jack, lower the trailer tongue until the coupler fully engages the hitch ball. If the coupler does not line up with the hitch ball, adjust the position of the tow vehicle.

Engage the coupler locking mechanism. In the engaged position, the locking mechanism securely holds the coupler to the hitch ball.

Insert a pin or lock through the hole in the locking mechanism. (The Demco adjustable couplers are not required to have a pin but have the option)

Be sure the coupler is all the way on the hitch ball and the locking mechanism is engaged. A properly engaged locking mechanism will allow the coupler to raise the rear of the tow vehicle. Using the trailer jack, test to see that you can raise the rear of the tow vehicle by 1 inch, after the coupler is locked to the hitch

^ Notice

Overloading can damage the tongue jack. Do not use the tongue jack to raise the tow vehicle more than 1 inch.

If the coupler cannot be secured to the hitch ball, do not tow the trailer. Call **Boss Trailers** at **903-703-9220** or your dealer for assistance.

Lower the trailer so that its entire tongue weight is held by the hitch and continue retracting the jack to its fully retracted position.

Rig the safety chains

Safety Chain Arrangement - Bumper Pull Trailer

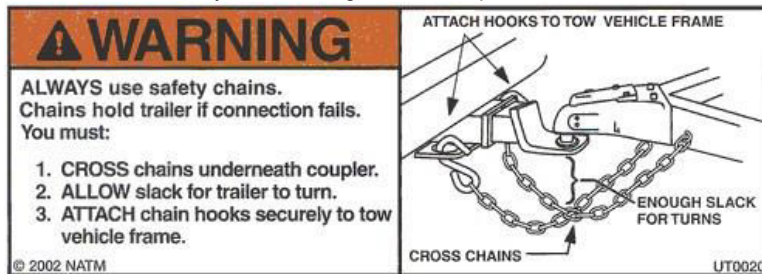

Visually inspect the safety chains and hooks for wear or damage. Replace worn or damaged safety chains and hooks before towing.

Rig the safety chains so that they:

Cris-cross underneath the coupler so if the trailer uncouples, the safety chains can hold the tongue up above the road.

Loop around a frame member of the tow vehicle or to holes provided in the hitch system (but do **not** attach them to an interchangeable part of the hitch assembly)

Attach "S" hooks up from underneath the hole (do not just drop into hole); and

Provide enough slack to permit tight turns, but not be close to the road surface to drag.

^ WARNING

Improper rigging of the safety chains can result in loss of control of the trailer and tow vehicle, leading to death or serious injury, if the trailer uncouples from the tow vehicle.

- Fasten chains to frame of tow vehicle. Do not fasten chains to any part of the hitch unless the hitch has holes or loops specifically for that purpose.
- Cross chains underneath hitch and coupler with enough slack to permit turning and to hold the tongue up if the trailer comes loose.

Attach and test electric breakaway brake system. If the coupler or hitch fails, a properly connected and working breakaway brake system will apply electric brakes on the trailer. The safety chains will keep the tow vehicle attached and as the brakes are applied at the trailer's axles, the trailer/tow vehicle combination will come to a controlled stop.

The breakaway brake system includes a battery, a switch with a pull pin, and a lanyard. Read and follow the instructions here as well as the instructions that have been prepared by the breakaway brake manufacturer. If you do not have these instructions, call **Boss Trailers** at **903-703-9220** for a free copy.

The breakaway brake system may be fitted with a "charging" capability that draws power from the tow vehicle. If the electrical system on your tow vehicle does not provide power to the breakaway brake battery, you must periodically charge the battery to keep the breakaway brake system in working order.

Electric Breakaway Brake Lanyard - Bumper Pull Trailer

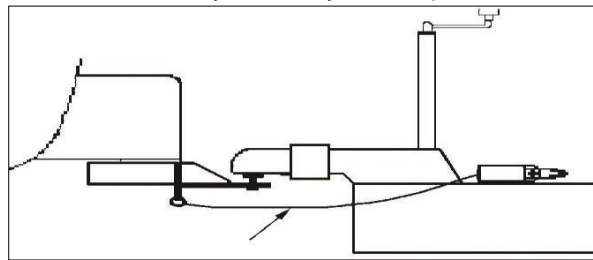

Connect the pull pin lanyard to the tow vehicle so that the pull pin will be pulled out before all the slack in the safety chains is taken up (see Electric Breakaway Brake Lanyard figure). Do **not** connect the pull pin cable to a safety chain or to the hitch ball or hitch ball assembly. This would keep the breakaway brake system from operating when it is needed. To test the break-away brake battery, remove the pull pin from the switch and attempt to pull the trailer forward. You should feel the trailer resisting being towed, but the wheels will not necessarily be locked. If the brakes do not function, do not tow the trailer until brakes, or battery, are repaired.

Immediately replace the pull pin. The breakaway brake system battery discharges rapidly when the pull pin is removed.

^ WARNING

An ineffective breakaway brake system can result in a runaway trailer, leading to death or serious injury if the coupler or ball hitch fails.

Connect the breakaway cable to the tow vehicle, and **NOT** to the hitch, ball, or support.

Before towing the trailer, test the function of the breakaway brake system. If the breakaway brake system is not working, do not tow the trailer. Have it serviced or repaired.

Do **not** tow the trailer with the breakaway brake system **ON** because the brakes will overheat which can result in permanent brake failure.

^ WARNING

Failure to replace the pull pin will prevent brakes from working, leading to loss of control, serious injury or death.

If you do not use your trailer for three or more months, or during winter months:

Store the battery indoors; and
Charge the battery every three months.

Replace the breakaway brake battery according to the intervals specified by battery manufacturer.

Connect the electrical cables
Connect the trailer lights to the tow vehicle's electrical system using the electrical connectors.

Check all lights for proper operation.

Clearance and Running Lights (Turn on tow vehicle headlights).

Brake Lights (Step on tow vehicle brake pedal).

Turn Signals (Operate tow vehicle directional signal lever).

Check electric brakes for proper operation using brake controller mounted in the cab.

If your trailer has electric brakes, your tow vehicle will have an electric brake controller that sends power to the trailer brakes. Before towing the trailer on the road, you must operate the brake controller while trying to pull the trailer to confirm that the electric brakes operate. While towing the trailer at less than 5 m.p.h., manually operate the electric brake controller in the tow vehicle cab. You should feel the operation of the trailer brakes.

^ WARNING	
Improper electrical connection between the tow vehicle and the trailer will result in inoperable lights and electric brakes and can lead to collision.	
Before each tow:	
<ul style="list-style-type: none">• Check that the taillights, brake lights and turn signals work• Check that the electric brakes work by operating the brake controller inside the tow vehicle	

Uncoupling the Ball Hitch Trailer with Tongue Jack

Follow these steps to uncouple your ball hitch trailer from the tow vehicle:

Block trailer tires to prevent the trailer from rolling, before jacking the trailer up.

Disconnect the electrical connector.

Disconnect the breakaway brake switch lanyard.

Disconnect the safety chains from the tow vehicle.

Unlock the coupler and open it.

Before extending jack, make certain the ground surface below the jack pad will support the tongue load.

Rotate the jack handle (or crank) clockwise. This will slowly extend the jack and transfer the weight of the trailer tongue to the jack. Trailer with Gooseneck Coupler and Drop-leg Jack

A gooseneck coupler on the trailer connects to a gooseneck ball that you must have installed in the bed of the tow vehicle. This system of coupling a trailer to a tow vehicle permits the tow vehicle to turn to sharper angles than are permitted by a bumper hitch system. A gooseneck coupler consists of a tube in an inverted "U" shape and a gooseneck ball receiver. "Trailer with Gooseneck Coupler" figure shows a trailer with a gooseneck coupler.

Trailer with Gooseneck Coupler



Gooseneck Coupler Open and Closed



We have installed a Gooseneck ball receiver that is suitable for the size and weight of the trailer. The load rating of the coupler and the necessary ball size are listed on the gooseneck.

You must provide a gooseneck ball and support structure that is marked with a rating that meets or exceeds the GVWR of your trailer **and** matches the size of the gooseneck ball receiver. If the gooseneck ball is too small, is underrated, is loose or is worn, the trailer can come loose from the tow vehicle, and may lead to death or serious injury.

THE TOW VEHICLE, SUPPORT STRUCTURE AND GOOSENECK BALL MUST HAVE A RATED TOWING CAPACITY EQUAL TO OR GREATER THAN THE TRAILER GROSS VEHICLE WEIGHT RATING (GVWR).

IT IS ESSENTIAL THAT THE GOOSENECK BALL BE OF THE SAME SIZE AS THE GOOSENECK BALL RECEIVER.

The ball size and load rating (capacity) are marked on the ball; hitch capacity is marked on the hitch.

^ WARNING

Coupler-to-hitch mismatch can result in uncoupling, leading to death or serious injury.

Be sure the **LOAD RATING** of the hitch ball is equal or greater than the load rating of the coupler.

Be sure the **SIZE** of the hitch ball matches the size of the coupler.

The height of the ball receiver on the trailer must be adjusted to match the height of the gooseneck ball on your tow vehicle, so that:

There is clearance between the bottom of the trailer and the sides of the tow vehicle bed; and
The trailer is level and allows equal weight distribution on tandem axles.

The "Gooseneck Height Adjustment" figure shows the gooseneck height adjustment. The gooseneck height adjustment bolts, which have a "cup" that makes a gripping impression into the gooseneck tube, must be tight so that the trailer does not drop to a lower position. Do not overtighten because the tube can be deformed. After tightening the bolts, tighten the jam nuts on the bolts.

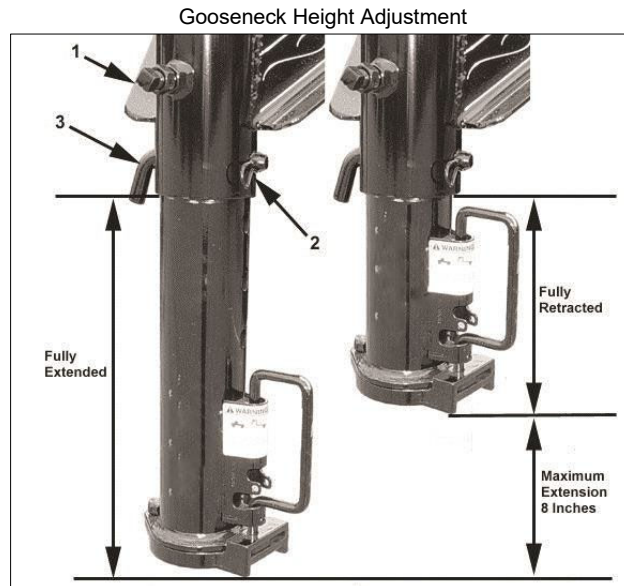

^ WARNING

Improper gooseneck height adjustment can result in overloaded tires, blowout, and loss of control, leading to death or serious injury.

Adjust the gooseneck receiver so that the loaded trailer is level.

A trailer having a gooseneck hitch will have one or two drop leg jacks for raising and lowering the gooseneck ball receiver. Because several drop leg jack mechanisms are available, the general instructions below may vary slightly from the jack manufacturer's instructions. If the trailer jack on your trailer does not resemble the jack shown in the figures, follow the jack instructions provided by the jack manufacturer. If you do not have these instructions, call **Boss Trailers at 903-703-9220** for a free copy.

Before attempting to tow the trailer:

Be sure the size and rating of the gooseneck ball match the size and rating of the receiver. Gooseneck balls and receivers are marked with their size and ratings.

Wipe the gooseneck ball clean and inspect it visually and by feel for flat spots, cracks, and pits.

^ WARNING

A worn, cracked, or corroded gooseneck ball can fail while towing, and may result in death or serious injury. Before coupling the trailer, inspect the gooseneck ball for wear, corrosion, and cracks; and replace worn or damaged gooseneck ball.

Rock the ball to make sure it is tight to the ball support, and visually check that the gooseneck ball nut is solid against the lock washer and ball support frame.

^ WARNING

A loose gooseneck ball can result in uncoupling, leading to death or serious injury. Be sure the gooseneck ball nut is tight before coupling the trailer.

Wipe the inside and outside of the receiver clean and inspect it visually for cracks; and feel the inside of the receiver for worn spots and pits. If any of these conditions exist, have the receiver replaced before coupling the trailer.

Lubricate the inside of the gooseneck ball receiver with automotive bearing grease. Be sure the receiver is tight to the trailer. All receiver fasteners must be visibly solid against the trailer frame.

Release the jack handle or crank from its holder (see "Drop Leg Jack" figure).

Make certain the ground beneath the jack foot is firm enough to support the tongue weight. Rotate the handle/crank clockwise to raise the bottom surface of the gooseneck to be above the top of the gooseneck ball. Prepare the ball receiver and gooseneck ball. Release the lock plate on the gooseneck ball receiver. With the spring-loaded lock plate locking pin in the OPEN position, rotate the lock plate to a position that allows the gooseneck ball to enter the receiver (see "Gooseneck Height Adjustment" figure).

Slowly back up the tow vehicle so that the gooseneck ball is aligned under the gooseneck ball receiver.

^ WARNING

If the trailer drops during coupling, death or serious injury may result. There must be no one under the trailer or coupler before or during the coupling operation.

Couple the trailer to the tow vehicle

Rotate the jack handle counter-clockwise. This will retract the jack causing the gooseneck ball receiver to drop down so it can fully engage the gooseneck ball and transfer the weight of the trailer tongue to the towing vehicle hitch. If the receiver does not line up with the ball, raise the receiver again and adjust the position of the tow vehicle. Then lower the receiver over the ball. When the drop leg base is no longer resting on the ground, the towing vehicle hitch is holding all the weight of the trailer tongue.

Close the lock plate on the gooseneck ball receiver.

Drop Leg Jack



Move the spring-loaded lock plate locking pin to the CLOSED position. Be sure the locking pin is holding the lock plate.

Be sure the receiver is all the way on the gooseneck ball and the lock plate is engaged. A properly engaged locking mechanism will allow the coupler to raise the rear of the tow vehicle. Using the trailer jack, test to see that you can raise the rear of the tow vehicle by 1 inch.

^ Notice

Overloading can damage the drop leg jack. Do not use the drop leg jack to raise the tow vehicle more than 1 inch.

If the gooseneck ball cannot be secured to the receiver, do not tow the trailer. Call **Boss Trailers** at **903-703-9220** or your dealer for assistance.

After testing to see that the receiver is properly secured and locked to the ball, retract the jack to its fully retracted position.

Return the drop legs to their upper positions. The drop legs are held in the lowered position with a plunger pin. Rotating the plunger pin while pulling it outward will cause it to come out of engagement with the drop leg and the leg will rapidly rise.

^ Caution

The drop legs are heavily spring loaded in the lowered position. They will rapidly return to the upper position when released and can inflict serious bruises, scrapes or pinching.

Keep your feet, shins, and hands well clear of the drop legs and drop leg bases when releasing the drop legs.

Always wear shoes or boots while performing this operation.

Rig the safety chains

Visually inspect the safety chains and hooks for wear or damage. Replace worn or damaged safety chains and hooks before towing.

Rig the safety chains so that they attach to the "safety chain receivers" in the bed of the truck. If you are not certain of the hitch provisions for receiving safety chains, contact the hitch manufacturer or installer. **DO NOT** attach the safety chains to the gooseneck ball or its support; and

Rig the safety chains so they have sufficient slack to permit turning, but not too much slack – the safety chains must keep the gooseneck on the tow vehicle bed if the trailer uncouples.

^ WARNING

Improper rigging of the safety chains can result in loss of control of the trailer and tow vehicle, leading to death or serious injury, if the trailer uncouples from the tow vehicle.

- Fasten chains to safety chain receivers on the hitch, not to ball.
- Have sufficient slack to permit turning and to keep gooseneck on bed of tow vehicle if the trailer comes loose.

Attach and test the breakaway brake system

If the coupler or hitch fails, a properly connected and working breakaway brake system will apply electric brakes on the trailer. The safety chains will keep the tow vehicle attached and as the brakes are applied at the trailer's axles, the trailer/tow vehicle combination will come to a controlled stop.

The breakaway brake system includes a battery, a switch with a pull pin, and a breakaway brake controller. Read and follow the instructions here as well as the instructions that have been prepared by the breakaway brake controller manufacturer. If you do not have these instructions, call **Boss Trailers** at **903-703-9220** for a free copy.

Safety Chains – Gooseneck

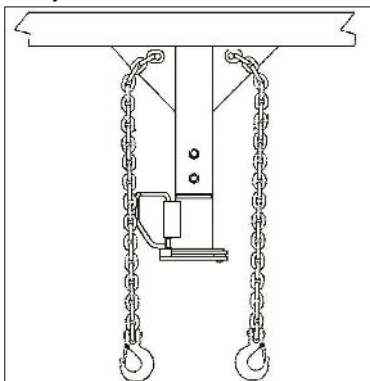

Electric Breakaway Brake Lanyard - Gooseneck

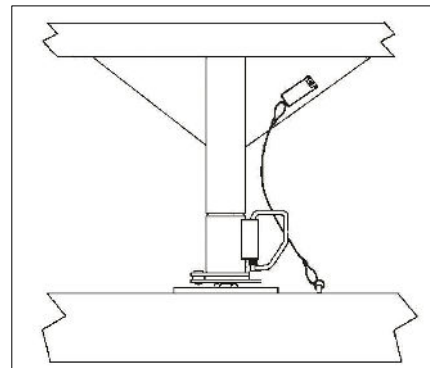

The breakaway brake system may be fitted with a charging facility that draws power from the tow vehicle. If the electrical system on your tow vehicle does not provide power to the breakaway brake battery you must periodically charge the battery on the trailer to keep the breakaway brake system in working order.

Visually inspect the breakaway brake system for broken parts.

Connect the pull pin cable to the tow vehicle so that the pull pin will be pulled out before all the slack in the safety chains is taken up (see "Safety Chains" figure). Do **not** connect the pull pin cable to a safety chain or a safety chain receiver or to the gooseneck ball or its support. This would keep the breakaway brake system from operating when it is needed. Contact the hitch manufacturer or installer if you are not certain of the hitch provisions for breakaway brake connection.

To check the break-away brake battery pull out the pull pin from the switch and attempt to pull the trailer forward. You should feel the trailer resisting being towed, but the wheels will not necessarily lock up.

Immediately replace the pull pin. The breakaway brake system battery discharges rapidly when the pull pin is removed.

^ WARNING
An ineffective or inoperative breakaway brake system can result in a runaway trailer leading to death or serious injury if the coupler or hitch fails.
Connect the breakaway cable to the tow vehicle, and NOT to the safety chain, safety chain receiver, gooseneck ball or gooseneck ball support.
Test the function of the breakaway brake system before towing the trailer. Do not tow the trailer if the breakaway brake system is not working. Have it serviced or repaired.

Do **not** tow the trailer with the breakaway brake system ON because the brakes will overheat which can result in permanent brake failure.

^ WARNING
Failure to replace the pull pin will prevent brakes from working, leading to loss of control, serious injury or death.

If you do not use your trailer for three or more months, or during winter months:

Store the battery indoors; and
Charge the battery every three months.

Replace the breakaway brake battery at intervals recommended by the battery manufacturer's instructions.
Connect the electrical cables
Connect the trailer lights to the tow vehicle's electrical system using the electrical connectors.

Check all lights for proper operation:

Clearance and Running Lights (Turn on tow vehicle headlights).
Brake Lights (Step on tow vehicle brake pedal).
Turn Signals (Operate tow vehicle directional signal lever).

Check electric brakes for proper operation

If your trailer has electric brakes, your tow vehicle will have an electric brake controller that sends power to the trailer brakes. Before towing the trailer on the road, you must operate the brake controller while trying to pull the trailer to confirm that the electric brakes operate. While towing the trailer at less than 5 m.p.h., manually operate the electric brake controller in the tow vehicle cab. You should feel the operation of the trailer brakes.

^ WARNING
Improper electrical connection between the tow vehicle and the trailer will result in inoperable lights and electric brakes and can lead to collision.
Before each tow:
<ul style="list-style-type: none">• Check that the taillights, brake lights and turn signals work• Check that the electric brakes work by operating the brake controller inside the tow vehicle

Uncoupling the Gooseneck Trailer with Drop-leg Jack
Follow these steps to uncouple your gooseneck hitch trailer from the tow vehicle:

Block trailer tires to prevent the trailer from rolling, before jacking the trailer up
Disconnect the electrical connector.

Disconnect the breakaway brake switch lanyard.
Disconnect the safety chains from the tow vehicle.
Move the spring-loaded gooseneck receiver lock plate locking pin to the OPEN position (see “Gooseneck Height Adjustment” figure). Rotate the lock plate to a position that permits the gooseneck ball to exit the receiver.
Before releasing drop leg jack, make certain ground surface below jack base will support the trailer tongue load.
Rotate the drop leg plunger pin handle so that the plunger pin is released from the drop leg (see “Drop Leg Jack” figure). Push down on the drop leg base with your foot to place a drop leg to the desired lowered position.
Rotate the plunger pin handle so that the plunger pin is attempting to engage the drop leg (see “Drop Leg Jack” figure) Slowly raise your foot, permitting the drop leg to raise. The plunger pin will engage a hole in the drop leg.

^ Caution

The drop legs are heavily spring loaded in the lowered position. They will rapidly return to the upper position when released and can inflict serious bruises, scrapes or pinching.

Keep your feet, shins, and hands well clear of the drop legs and drop leg bases when releasing the drop legs.

Always wear shoes or boots while performing this operation

Be sure the plunger pin is fully engaged. Push it in by hand if necessary. The bent part of the plunger pin handle must be touching the plunger pin housing.

If your trailer has two drop leg jacks, lower them both to the same level, following the above instructions.

^ Notice

If the drop legs are not set at the same level, one of the drop leg jacks can be overloaded and can be damaged.

Release the handle (or crank) from its holder and engage it with the jack shaft (see “Drop Leg Jack” figure).

Rotate the handle (or crank) from its hold and engage it with the jack shaft (see “Drop Leg Jack” figure).

Rotate the handle (or crank) clockwise to slowly extend the jack and transfer the weight of the trailer tongue to the jack.

On two speed jacks, pushing the handle shaft toward the gearbox can perform rapid extension. This shifts the gearbox into a high-speed mode.

When the drop leg base contacts the ground, shift the gearbox into low gear mode by pulling or pushing on the handle shaft until it locks into low gear.

^ Notice

Do not use high gear to lift the trailer; the drop leg jack mechanism can be damaged.

High gear is used only to rapidly move the drop leg base into contact with the ground.

Continue to extend the jack(s), making sure that the ground is providing stable and level support for the trailer.

After the jack(s) are extended and the gooseneck ball receiver is well clear of the gooseneck ball, to permit driving the tow vehicle away, disengage the handle from its shaft and return to its holder.

The breakaway brake system may be fitted with a charging facility that draws power from the tow vehicle. If the electrical system on your tow vehicle does not provide power to the breakaway brake battery, you must periodically charge the battery to keep the breakaway brake system in working order.

Visually inspect the breakaway brake system for broken parts.

Connect the pull pin cable to the tow vehicle (see “Electric Breakaway Brake Lanyard” figure). Do **not** connect to kingpin or its support.

To test the break-away battery remove the pull pin from the switch and attempt to pull the trailer forward. You should feel the trailer resisting being towed, but the wheels will not necessarily lock-up.

Immediately replace the pull pin. The breakaway brake system battery discharges rapidly when the pull pin is removed.

^ WARNING

An ineffective breakaway brake system can result in a runaway trailer leading to death or serious injury if the coupler fails. Connect the breakaway cable to the tow vehicle, and NOT to the kingpin or its support.

Before towing the trailer, test the function of the breakaway brake system. If the breakaway brake system is not working, do not tow the trailer. Have it serviced or repaired.

Do **not** tow the trailer with the breakaway brake system ON because the brake will overheat which can result in permanent brake failure.

^ WARNING

Failure to replace the pull pin will prevent brakes from working, leading to loss of control, serious injury or death.

If you do not use your trailer for three or more months, or during winter months:

Store the battery indoors; and
Charge the battery every three months.

Replace the breakaway brake battery at intervals recommended by the battery manufacturer

Connect the electrical cables

Connect the trailer lights to the tow vehicle's electrical system using the electrical connectors. Check all lights for proper operation:

Clearance and Running Lights (Turn on tow vehicle headlights).

Brake Lights (Step on Tow vehicle brake pedal).

Turn Signals (Operate tow vehicle directional signal lever).

Check brakes for proper operation: While towing the trailer at less than 5 m.p.h., manually operate the electric brake controller in the tow vehicle cab. You should feel the operation of the trailer brakes.

^ WARNING

Improper electrical connection between the tow vehicle and the trailer will result in inoperable lights and electric brakes and can lead to collision.

Before each tow:

- Check that the taillights, brake lights and turn signals work
- Check that the electric brakes work by operating the brake controller inside the tow vehicle

4. LOADING THE TRAILER

Improper trailer loading causes many accidents and deaths. To safely load a trailer, you must consider:

- Overall load weight;
- Load weight distribution;
- Proper tongue weight; and
- Securing the load properly.

To determine that you have loaded the trailer within its rating, you must consider the *distribution* of weight, as well as the total weight of the trailer and its contents. The trailer axles carry most of the total weight of the trailer and its contents (Gross Vehicle Weight, or “GVW”). The remainder of the total weight is carried by the tow vehicle hitch. It is essential for safe towing that the trailer-tongue and tow vehicle hitch carry the proper amount of the loaded trailer weight, otherwise the trailer can develop an undesirable sway at towing speeds, or the rear of the towing vehicle can be overloaded. Read the “Tongue Weight” section below.

The load distribution must be such that no component part of the trailer is loaded beyond its rating. This means that you must consider the rating of the tires, wheels, and axles. For tandem and triple axle trailers, you must make sure that the front-to-rear load distribution does not result in overloading any axle.

Towing stability also depends on keeping the center of gravity as low as possible. Load heavy items on the floor and over the axles. When loading additional items, be sure to maintain even side-to-side weight distribution and proper tongue weight. The total weight of the trailer and its contents must never exceed the total weight rating of the trailer (Gross Vehicle Weight Rating, or “GVWR”).

^ WARNING

An overloaded trailer can result in loss of control of the trailer, leading to death or serious injury.

Do not exceed the trailer Gross Vehicle Weight Rating (GVWR) or the Gross Axle Weight Rating (GAWR).

Do not load a trailer so that the weight on any tire exceeds its rating.

4.1. TONGUE WEIGHT

It is critical to have a portion of the trailer load carried by the tow vehicle. That is, the trailer tongue must exert a downward force on the hitch. This is necessary for two reasons. First, the proper amount of tongue weight is necessary for the tow vehicle to be able to maintain control of the tow vehicle/trailer system. If, for example, the tongue exerts an upward pull on the hitch, instead of pushing down on it (because the trailer is overloaded behind its axle(s)), the rear wheel of the tow vehicle can lose traction or grip and cause loss of control. Also, even if there is some weight on the tongue, but not enough weight on the tongue, the trailer can become unstable at high speeds. Remember, the faster you go the more likely the trailer is to sway.

If, on the other hand, there is too much tongue weight, the tow vehicle is prone to jack-knife. Furthermore, the front wheels of the tow vehicle can be too lightly loaded and cause loss of steering control and traction if the front wheels are driving.

In addition to tow vehicle control, tongue weight is necessary to ensure that the trailer axle(s) do not exceed their Gross Axle Weight Rating (GAWR).

The table below has “rules of thumb” for proper tongue weight.

In the table below, the second column notes the rule of thumb percentage of total weight of the trailer plus its cargo (Gross Vehicle Weight, or “GVW”) that should appear on the tongue of the trailer. For example, a trailer with a gooseneck hitch, with a loaded weight of 12,000 pounds, should have 2025% (of 12,000 pounds) on the tongue. That is, the example trailer would have 2,400 to 3,000 pounds on its tongue.

The numbers quoted above are for example purposes only and should be tailored to the specific trailer. For questions regarding the actual percent of tongue weight for the trailer, check with the manufacturer for specifics.

^ WARNING

Improper tongue weight (load distribution) can result in loss of control of the trailer, leading to death or serious injury.

Make certain that tongue weight is within the allowable range.

Be sure to:

- Distribute the load front-to-rear to provide proper tongue weight (see chart).
- Distribute the load evenly, right, and left, to avoid tire overload; and
- Keep the center of gravity low.

Checking Tongue Weight

To check the tongue weight, the tow vehicle and trailer must be on level ground, as they will be when the trailer is being towed.

For lighter trailers, the recommended method of checking tongue weight is to use an accessory called a “tongue weight scale.” If a tongue weight scale is not available from your dealer, call **Boss Trailers** at **903-703-9220** for assistance.

An alternate method of checking tongue weight involves the use of a bathroom scale. The loaded trailer must be on a smooth and level surface, and you must block the trailer wheels, front and rear.

Bathroom Scale Method for Checking Tongue Weight

^ WARNING

An unrestrained trailer can fall off its support, resulting in serious injury or death.

Before checking tongue weight, block trailer wheels, front and rear.

- Raise the tongue of the trailer with the jack.
 - Place a bathroom scale on the ground, directly below the coupler.
 - Place a strong block support (such as a cement block) on the scale – note the scale reading for the weight of the block support.
 - Lower the tongue until the coupler rests on the block support and the jack is ½ inch above the ground.
 - The scale reading, minus the weight of the block support is the tongue weight.
 - If the tongue weight exceeds the capacity of a bathroom scale, you can use “leverage” to divide the tongue weight between the bathroom scale and another support (see “Checking Tongue Weight” figure).
 - Raise the tongue of the trailer with the jack.
 - Arrange a brick, 2 x 4 (or 4 x 4) board, bathroom scale and pipes as shown in “Checking Tongue Weight” figure. The brick should be about the same thickness as the bathroom scale.
 - Leave a 3-foot distance between the pipes and place the coupler about 2 feet from the pipe on the bathroom scale.
 - Place a strong block support (such as a cement block) on the board. Note the weight indicated on the scale.
 - Lower the tongue until the coupler rests on the block support and the jack is ½ inch above the ground.
 - Subtract the scale reading with the block and board alone from the scale reading with the trailer on the block. Multiply the result by 3 to get the actual tongue weight.
- Example:
- Scale reading with block and board alone = 10 lbs.
 - Scale reading with trailer coupler resting on board = 50 lbs.
 - Actual tongue weight: $(50-10) \times 3 = 120$ lbs.

For heavier trailers it is easier to go to a truck stop where there is a “certified” scale. Pull only the tow vehicle onto the scale and get the weight. This weight must be less than your tow vehicle’s GVWR. Pull the trailer onto the scale and decouple it from the tow vehicle, leaving just the trailer on the scale. Get a “ticket”, which lists the total trailer weight. Re-connect the trailer to your tow vehicle and drive the tow vehicle wheels off the scale, just leaving the trailer axles on the scale. Get a second “ticket”, which lists the trailer’s axle weight. Simply subtract the axle weight from the total weight to determine the hitch weight.

While you are at the scale, you should weigh the entire combination vehicle. This result should be less than the Gross Combined Weight Rating (GCWR) for your towing vehicle. Some scales allow you to get individual axle weights also. If this is possible, get the tow vehicle’s front and rear axle weights to make sure they are in the same proportion as the tow vehicle alone, and that the rear axle is not overloaded. This is the best way to check that a weight distribution (or load leveling) hitch is adjusted properly, i.e., you have the proper number of chain links attached to the snap-up brackets.

Checking Tongue Weight

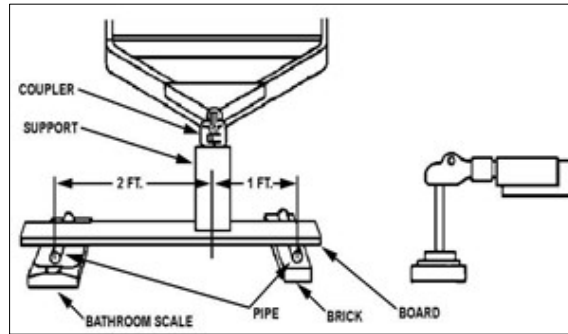

4.2. SECURING THE CARGO

Since the trailer “ride” can be bumpy and rough, you must secure your cargo so that it does not shift while the trailer is being towed.

^ WARNING

Shifting cargo can result in loss of control of the trailer and can lead to death or serious injury.
Tie down all loads with proper sized fasteners, ropes, straps, etc.

4.2.1. DISTRIBUTING THE CARGO (OPEN TRAILER)

Couple the trailer to the tow vehicle before loading. This is essential for the bumper pull trailer because the tongue of a bumper pull trailer can rise during loading before the cargo is properly distributed. To measure the tongue weight, you will have to uncouple the trailer after it is loaded.

Do not transport people, containers of hazardous substances, cans, or containers of flammable substances, such as gasoline, kerosene, paint, etc. However, fuel in the tank of an off-road vehicle, or a car or motorcycle, etc. may be carried on your open trailer.

^ WARNING

Do not transport flammable, explosive, poisonous or other dangerous materials in your trailer.

Preparing the Trailer for Loading Before loading cargo onto the trailer:

- Inspect the deck of the trailer for corrosion or damage; and
- Inspect the hold down openings and/or “D”-rings. Hold down openings must be sturdy with no visible cracks or kinks. D-rings must be tight to the deck and must not be bent.

If the deck or any required hold-down is damaged, do not load the cargo. Bring the trailer to your dealer or a competent repair service before using it to carry cargo.

^ WARNING

Damaged or loose “D”-rings can break, allowing cargo to become loose inside the trailer. Loose cargo can shift the center of gravity, and result in loss of control of the trailer.

Inspect “D”-rings and test them for looseness before loading cargo.

Do not use a damaged or loose “D”-ring to secure cargo.

Loading a Rigid-deck Trailer

Open trailers have either a rigid-deck or a pivoting deck, depending on the exact model. This subsection describes loading a rigid-deck trailer.

Before loading a rigid-deck trailer, couple the trailer to the tow vehicle and make sure the rigid-deck is level. Do not load or unload the trailer when the deck is not level.

Make sure the top of the ramp (or ramps) is secure to the trailer, and the bottom is resting on firm ground. Pockets may be provided to hold the ramp to the frame of the trailer.

^ WARNING

Load can suddenly move or topple, which can result in death or serious injury.
Do not load or unload your open trailer unless it is prevented from tipping and is on firm and level ground.

Load the cargo onto the trailer with approximately 60% of the cargo in the front half of the trailer.

Secure the cargo to the trailer using appropriate straps, chains, and tensioning devices.

Since the trailer "ride" can be bumpy and rough, you must secure your cargo so that it does not shift while the trailer is being towed.

^ WARNING

Shifting cargo can result in loss of control of the trailer and can lead to death or serious injury.
Tie down all loads with proper sized fasteners, ropes, straps, etc.

Return the ramp(s) to their stowed position(s) and secure them so that they will not move during transit

5. CHECKING THE TRAILER BEFORE AND DURING EACH TOW

5.1. PRE-TOW CHECKLIST

Before towing, double-check all these items: See section 7.1, "Inspection, Service & Maintenance Summary Charts," for more information.

- Tires, wheels, and lug nuts (see the "Major Hazards" section starting on page 6 of this manual)
- Tire Pressure. Inflate tire on trailer and tow vehicle to the pressure stated on the VIN / Certification label.
- Coupler secured and locked (see the "Coupling and Uncoupling the Trailer" section starting on page 22 of this manual)
- Safety chains properly rigged to tow vehicle, not to hitch or ball (see the "Coupling to the Tow Vehicle" chapter starting at Page 22 of this manual)
- Test of lights: Tail, Stop, and Turn Lights
- Test trailer brakes.
- Safety breakaway switch cable fastened to tow vehicle, not to safety chains (see the "Coupling to the Tow Vehicle" chapter starting at Page 22 of this manual)
- Cargo properly loaded, balanced, and tied down (see the "Loading the Trailer" chapter starting at page 35 of this manual)
- Tongue weight and weight distribution set-up.
- Doors and gates latched and secured
- Fire extinguisher
- Flares and reflectors

5.2. MAKE REGULAR STOPS

After each 50 miles, or one hour of towing, stop and check the following items:

- Coupler secured
- Safety chains are fastened and not dragging
- Cargo secured
- Cargo door latched and secured

6. BREAKING-IN A NEW TRAILER

6.1. RETIGHTEN LUG NUTS AT FIRST 10, 25 & 50 MILES

Wheel lugs can shift and settle quickly after being first assembled, and must be checked after the **first** 10, 25 and 50 miles of driving. Failure to perform this check may result in a wheel coming loose from the trailer, causing a crash leading to death or serious injury.

^ WARNING

Lug nuts are prone to loosen after initial installation, which can lead to death or serious injury.

Check lug nuts for tightness on a new trailer or when wheel(s) have been remounted after the first 10, 25 and 50 miles of driving.

See Section 7.2.12.2 page 50 on Proper Torque

Technique.

6.2. ADJUST BRAKE SHOES AT FIRST 200 MILES

Brake shoes and drums experience a rapid initial wear. The brakes must be adjusted after the first 200 miles of use, and each 3,000 miles thereafter.

Some axles are fitted with a mechanism that will automatically adjust the brake shoes when the trailer is "hard braked" from a rearward direction. Read your axle and brake manual to see if your brakes adjust automatically. If you do not have the axle and brake manual, call **Boss Trailers** at **903-703-9220** for a free copy.

A hard stop is used to:

- Confirm that the brakes work;
- Confirm that the trailer brakes are properly synchronized with the tow vehicle brakes using the brake controller in the tow vehicle
- Adjust the brake shoes, as necessary.
- For surge brakes check the Master cylinder reservoir for fluid.

If your trailer is not fitted with automatically adjusting brakes, the brakes will need to be manually adjusted. See section 7.2.5.2, "Manually Adjusting Brake Shoes," for instructions.

6.3. SYNCHRONIZING THE BRAKE SYSTEMS

Trailer brakes are designed to work in synchronization with the brakes on the tow vehicle. When the tow vehicle and trailer braking systems are synchronized, both braking systems contribute to slowing, and the tongue of the trailer will neither dive nor rise sharply.

^ WARNING

If trailer and tow vehicle brakes do not work properly together, death or serious injury can occur.

Road test the brakes in a safe area at no more than 30 m.p.h. before each tow

To ensure safe brake performance and synchronization, read and follow the axle/brake and the brake controller manufacturers' instructions. If you do not have these instructions, call **Boss Trailers** at **903-703-9220** for a free copy.

TIRE PRESSURE

Check tire pressures on both the trailer and tow vehicle. Inflate to the maximum shown on the VIN / Certification Label.

6.4. ACCESSORY BATTERY

Your trailer may be outfitted with an accessory battery that operates lighting, electric landing gear, dump body, slide-outs, or other accessories. An accessory battery may be kept charged either by the tow vehicle or by the generator or shore power.

A disconnect switch may be provided to disconnect the accessory battery when you do not plan to be using the trailer for an extended period, such as seasonal storage. If there is no disconnect switch, then remove the cables from the battery terminals.

The accessory battery must be kept in a charged condition during storage. The battery could freeze and break if it becomes discharged. Shore power is the delivery of electrical power from another source to a power inlet on your trailer. To connect your trailer to this source, you must have a "shore power" cord, specifically designed for this use. **DO NOT USE AN ORDINARY EXTENSION CORD.** The trailer end of this cord is connected to an electrical box on the trailer, sometimes referred to as a "motor base." This box contains circuit breakers and/or fuses and may include a power converter to change the shore power (usually 110 volts alternating current) into 12 volts direct current.

Do not assume that a shore power supply is correctly wired. Shore power may have incorrect polarity or not have the safety ground. Before connecting your trailer, you should test shore power by using a polarity and ground tester, which can be purchased at electronic stores. If you have shore power, your trailer may be fitted with Ground-Fault Interrupting outlets (GFI). If you have GFI protection, you must periodically test the outlets by pressing the "TEST" button that is located on the GFI-equipped outlet.

7. INSPECTION, SERVICE & MAINTENANCE

7.1. INSPECTION, SERVICE & MAINTENANCE SUMMARY CHARTS

You must inspect, maintain and service your trailer regularly to insure safe and reliable operation. If you cannot or are unsure how to perform the items listed here, have your dealer do them. Note: In addition to this manual, also check the relevant component manufacturer's manual.

Inspection and Service before Each Use		
Item	Inspection / Service	Manual Section Reference
Breakaway Brakes > Electric > Hydraulic	Check operation Check fluid level	Section 7.2.5.4
Breakaway Battery	Fully charged, connections clean	Section 7.2.5.3.A.(i)
Brakes, all types	Check operation	Section 6.3
Shoes and Drums	Adjust	Section 6.2 7.2.5.2
Brakes, Hydraulic - Vacuum Actuated	Check gauge for proper vacuum of 18 In. Hg. (inches of mercury)	Section 7.2.5.4.A
Coupler and Hitch Ball	Check for cracks, pits, and flats. Replace w/ball & coupler having trailer GVW Rating.	Section & 7.2.6.1
Gooseneck Ball	Check for cracks, pits, and flats. Replace w/ball & coupler having trailer GVW Rating.	Section & 7.2.6.2
Safety Chain(s) & Hooks	Check for wear and damage	Sections 0 & 0
Tires	Check tire pressure when cold. Inflate as needed.	Sections 5.1 & 7.2.10

Inspection, Service & Maintenance

Wheels - Lug Nuts (Bolts) & Hub	Check for tightness Tighten. For new and remounted wheels, check torque after first 10, 25 & 50 miles of driving and after any impact	Section 5.1 Sections 6.1 & 7.2.12.2
--	--	--

Inspection and Service each 3 Months or 3,000 Miles		
Item	Inspection / Service	Manual Section Reference
Structure > Rubber mats and floor > Hinges, Doors, and dividers	Remove mats. Wash both sides. Wash floor Inspect. Repair or replace damaged, worn, or broken parts	Section 7.2.2 Section 7.2.2

Inspection and Service each 6 Months or 6,000 Miles		
Item	Inspection / Service	Manual Section Reference
Tires	Rotate @ 5,000 miles	Section 7.2.10
Brakes, electric > Magnets > Controller (in tow vehicle)	Check wear and current draw Check power output (amperage) and modulation	Section 7.2.5.3.B See Controller Mfr's Manual
Structure > Roof Vents > Windows	Clean dirt buildup, lubricate hinges and slides	Section 7.2.2
Tires	Inspect tread and sidewalls thoroughly. Replace tire when treads are worn, when sidewall has a bulge, or sidewall is worn	Section 7.2.10 Section 7.2.10

Inspection and Service Each Year or 12,000 Miles		
Item	Inspection / Service	Manual Section Reference
Brakes, all types > Shoes and drums	Check for scoring and wear. Replace per manufacturer's specifications	Section 7.2.5.1 See Brake Mfr's Manual
Jack, Drop-leg	Grease gears at top	See Jack Mfr's Manual
Structure > Frame members > Welds > Slide-out	Inspect all frame members, bolts & rivets. Repair or replace damaged, worn, or broken parts. Inspect all welds. Repair as needed Clean dirt build-up. Lubricate slides, shafts, and gears	Section 7.2.1 Section 7.2.2.2 Section 7.2.4

Wheels > Sealed Bearings (Hubs) > UNSEALED Bearings (Hubs) > Rims	Check and confirm free running. Replace if not (sealed bearings are not serviceable) Disassemble / inspect / assemble and repack. Replace promptly if immersed in water Inspect for cracks & dents. Replace as needed.	Section 7.2.12 Section 7.2.12.1 See Axle Mfr's Manual Section 7.2.11
Structure > Axle Attachment Bolts	Check BY DEALER	Section 7.2.1

7.2. INSPECTION AND SERVICE INSTRUCTIONS

7.2.1. AXLE BOLTS, FRAME, SUSPENSION, & STRUCTURE

^ WARNING

Worn or broken suspension parts can cause loss of control and injury may result.
Have trailer professionally inspected annually and after any impact.

To perform many of the inspection and maintenance activities, you must jack up the trailer. When jacking and using jack stands, place them to clear wiring, brake lines, and suspension parts (springs, torsion bars, etc.). Place jacks and jack stands inside of the perimeter strip on the supporting structure to which the axles are attached.

^ WARNING

Never crawl under your trailer unless it is on firm and level ground and resting on properly placed and secured jack stands.

7.2.2. TRAILER STRUCTURE

Because the trailer floor receives the most abuse, it will most likely corrode before any other part of the structure. This is particularly true for horse and livestock trailers, having floors subjected to urine and manure. The urine and manure are corrosive to the metal flooring and other structural parts of the trailer.

Remove the rubber mats from the floor of the trailer, and wash them, at least every three months. Using a power washer and a detergent solution, wash both sides of the rubber mat, as well as the floor and walls of the trailer. Rinse the rubber mat and the trailer floor and walls. Be sure the rubber mat and trailer floor are completely dry before replacing the rubber mat.

7.2.2.1. FASTENERS AND FRAME CENTERS

Inspect all the fasteners and structural frame members for bending and other damage, cracks, or failure. Repair or replace any damaged fastener and repair the frame member. If you have any questions about the condition or method of repair of fasteners or frame members, get the recommendation of, or have the repair done by, your dealer.

The various fastener types used on your trailer are:

- Bolts, which are used mainly for attaching door and gate hinges to the trailer body;
- Buck Rivets, which are used to attach the sides and roof panels of the body to each other, and to the frame of the trailer;

^ WARNING

Broken or damaged fasteners or welds can cause injury or damage to trailer and contents.
Inspect for and repair all damaged parts at least once a year.

7.2.2.2. WELDS

All welds can crack or fail when subjected to heavy loads or movement of cargo that was not properly tied to prevent movement. Any time that you know or suspect that the trailer has been subjected to heavy loads or movement of cargo, immediately inspect the welds and fasteners for damage. To prevent severe damage to your trailer, inspect all the welds for cracks or failure at least once a year.

^ WARNING

Improper weld repair will lead to early failure of the trailer structure and can cause serious injury or death.
Do not repair cracked or broken welds unless you have the skills and equipment to make a proper repair. If not, have the welds repaired by your dealer.

7.2.3. DROP RAMP TORSION SPRINGS

If your trailer has a drop-ramp door, the weight of the door may be partially held by a torsion spring and a cable. Stand to the side when opening the drop ramp. You could be hurt if you are behind the drop ramp and the counterbalance does not work.

Inspect the cable and cable ends regularly for fraying and signs of loosening. If released, a torsion spring can inflict serious injury.

The torsion spring and cable are not user serviceable. The torsion spring must be serviced by a person who is trained in torsion spring safety.

7.2.4. SLIDE-OUTS

The optional slide-out facility is fitted with shafts, bushing, gears and sliding members located on the underside of the trailer, these parts are exposed to road grime, water, and possible salt spray. Clean and lubricate the moving parts regularly to keep the slide-out from seizing.

Follow the instructions below to clean and lubricate the slide-out mechanism at least once per season, and more frequently if your trailer is operated in dusty or salt-spray environments.

- Clean the locations where the drive shaft passes through the bushings.
- Hand pack grease on the gears.
- Grease the sliding track.

7.2.5. TRAILER BRAKES

7.2.5.1. BRAKE SHOES & DRUMS

Properly functioning brake shoes and drums are essential to ensure safety. You must have your dealer inspect these components at least once per year, or each 12,000 miles.

The brake shoes must be adjusted after the first 200 miles of use, and each 3,000 miles thereafter. Most axles are fitted with a brake mechanism that will automatically adjust the brake shoes when the trailer is "hard braked" from a rearward direction. Read your axle and brake manual to see how to adjust your brakes. If you do not have this manual, call **Boss Trailers** at **903-703-9220** for a free copy.

7.2.5.2. MANUALLY ADJUSTING BRAKE SHOES

Most braking systems are not automatically adjusted by hard stopping. These brakes require manual adjustment. The following steps apply to adjust most manually adjustable brakes. Read your axle and brake manual to see how to adjust your brakes. If you do not have this manual, call **Boss Trailers** at **903-703-9220** for a free copy.

Jack up the trailer and secure it on adequate capacity jack stands.

Be sure the wheel and brake drum rotate freely.

Remove the adjusting-hole cover from the adjusting slot on the bottom of the brake backing plate.

With a screwdriver or standard adjusting tool, rotate the star wheel of the adjuster assembly to expand the brake shoes. Adjust the brake shoes out until the pressure of the linings against the drum makes the wheel very difficult to turn. Note: Your trailer maybe equipped with drop spindle axles. See axle manual for your axle type. You will need a modified adjusting tool for adjusting the brakes in these axles. With drop spindle axles, a modified adjusting tool with about an 80-degree angle should be used.

Rotate the star wheel in the opposite direction until the wheel turns freely with a slight drag.

Replace the adjusting-hole cover.

Repeat the above procedure on all brakes.

Lower the trailer to the ground.

7.2.5.3. ELECTRIC BRAKES

Two different types of electric brakes may be present on the trailer: an emergency electric breakaway system, which acts only if the trailer comes loose from the hitch and the breakaway pin is pulled. The other brake is an electric braking system that acts whenever the brakes of the tow vehicle are applied.

7.2.5.3.A. BREAKAWAY BRAKE

7.2.5.3.A. (i) BREAKAWAY BATTERY

This battery supplies the power to operate the trailer brakes if the trailer uncouples from the tow vehicle. Be sure to check, maintain and replace the battery according to the battery manufacturer' instructions.

^CAUTION

Extreme cold weather can degrade battery performance and cause brakes to not operate properly. Always check battery charge level before towing.

This switch causes the breakaway battery to operate the electric brakes if the trailer uncouples from the tow vehicle.

The pull cable for the pull pin is connected to the tow vehicle, and the switch is connected to the trailer. To check for proper functioning of the switch, battery, and brakes, you must pull the pin from the switch and confirm that the brakes apply to each wheel. You can do this by trying to pull the trailer with the tow vehicle, after pulling the pin. The trailer brakes may not lock, but you will notice that a greater force is needed to pull the trailer.

^ WARNING
If electric breakaway brakes do not operate when trailer is uncoupled from the tow vehicle, death or serious injury can occur.
Check emergency breakaway brake system BEFORE each tow.

Tow Vehicle Operated Electric Brakes

The electric brakes that operate in conjunction with the tow vehicle brakes must be "synchronized" so that braking is properly distributed to the tow vehicle brakes and the trailer brakes. For proper operation and synchronization, read and follow the axle/brake and the brake controller manufacturers' instructions. If you do not have these instructions, call **Boss Trailers** at **903-703-9220** for a free copy.

7.2.5.3.B. MAGNETS FOR ALL ELECTRIC BRAKES

To make certain an electrically operated braking system will function properly, you must have your dealer inspect the magnets at least once a year, or each 12,000 miles. See the brake manual for wear and current inspection instructions.

7.2.5.4. BRAKES, HYDRAULIC (VACUUM, AIR OR ELECTRIC OPERATED)

If your trailer has hydraulically operated brakes, they function the same way the hydraulic brakes do on your tow vehicle. The hydraulic braking system must be inspected by a dealer, at least as often as the brakes on the tow vehicle, but no less than once per year. This inspection includes an assessment of the condition and proper operation of the wheel cylinders, brake shoes, brake drums and hubs.

You must check the fluid level in the master cylinder reservoir at least every three months. If you tow your trailer an average of 1,000 miles per month in a hot and dry environment, you must check the brake fluid level once a month. The brake fluid reservoir is located on the tongue of the trailer or near the gooseneck. Fill with DOT 4 brake fluid.

7.2.5.4.A. VACUUM-OPERATED HYDRAULIC

When towing a trailer, the vacuum gauge, which is located inside the cab of the tow vehicle, must indicate 18 In. Hg. (inches of mercury) or more at all times.

^ WARNING
If the vacuum gauge in tow vehicle is not at or above 18 In. Hg. (inches of mercury), damage to the brake system will result and the brakes may become inoperable.

7.2.5.4.B. AIR PRESSURE-OPERATED HYDRAULIC

Air/hydraulic braking systems are typically used when the tow vehicle has a diesel engine. The tow vehicle has an air compressor that routes the air to an air/hydraulic mechanism, which sends brake fluid to the wheel cylinders.

The air pressure gauge in your tow vehicle indicates the current air pressure. See your tow vehicle manual for the proper air pressure.

7.2.5.4.C. ELECTRICAL-OPERATED HYDRAULIC

Electric/hydraulic braking systems, which are mounted on the trailer, use a small electrically driven pump to generate hydraulic pressure, which operates the brake cylinders. Like electrical brakes, an electric/hydraulic braking system is operated by an electrical signal from the tow vehicle.

7.2.6. TRAILER CONNECTION TO TOW VEHICLE

7.2.6.1. COUPLER AND BALL

The coupler on the trailer connects to the ball attached to the hitch on the tow vehicle. The coupler, ball and hitch transfer the towing forces between the tow vehicle and the trailer. Before each tow, coat the ball with a thin layer of automotive bearing grease to reduce wear and ensure proper operation; and check the locking device that secures the coupler to the ball for proper operation.

See the coupler manufacturer's manual for other inspection and maintenance activities. If you do not have this manual, call **Boss Trailers at 903-703-9220** for a free copy.

If you see or feel evidence of wear, such as flat spots, deformations, pitting or corrosion, on the ball or coupler, immediately have your dealer inspect them to determine the proper action to prevent possible failure of the ball and coupler system. All bent or broken coupler parts must be replaced before towing the trailer.

The coupler handle lever must be able to rotate freely and automatically snap into the latched position. Oil the pivot points, sliding surfaces, and spring ends with SAE 30W motor oil. Keep the ball pocket and latch mechanism clean. Dirt or contamination can prevent proper operation of the latching mechanism.

When replacing a ball, the load rating must match or exceed the GVWR of the trailer.

7.2.6.2. GOOSENECK

The gooseneck receiver on the trailer connects to a hitch-mounted ball on the towing vehicle. The receiver, ball and hitch transfer the towing forces between the tow vehicle and the trailer. Before each tow, coat the ball with a thin layer of automotive bearing grease to reduce wear and ensure proper operation; and check the locking device that secures the receiver to the ball for proper operation.

See the gooseneck ball receiver manufacturer's manual for other inspection and maintenance activities. If you do not have a manual for the receiver, call **Boss Trailers at 903-703-9220** for a free copy.

If you see or can feel evidence of wear, such as flat spots, pitting or corrosion, on the ball or receiver, immediately have your dealer inspect them to determine the proper action to prevent possible failure of the ball and receiver system.

When replacing a ball, the load rating must match or exceed the GVWR of the trailer.

7.2.6.3. FIFTH WHEEL KINGPIN

Before each tow, inspect the fifth wheel and kingpin for wear, and coat the contact surface of the fifth wheel plate with water-resistant Lithium-base grease. If you see evidence of wear on the fifth wheel or kingpin, immediately have your dealer inspect them to determine the proper action to prevent failure of the fifth wheel and kingpin system.

See the manual prepared by the manufacturer of the fifth wheel and kingpin for other inspection and maintenance activities. If you do not have this manual, call **Boss Trailers at 903-703-9220** for a free copy.

7.2.7. LANDING LEG OR JACK

If a grease fitting is present, you must use a grease gun to lubricate the jack mechanism. Grease the gears in the top of hand-cranked jacks once a year, by removing the top of the jack and pumping or hand packing grease into the gears.

7.2.8. LIGHTS AND SIGNALS

Before each tow, check the trailer taillights, stoplights, turn signals and any clearance lights for proper operation.

^ WARNING

If the vacuum gauge in tow vehicle is not at or above 18 in. Hg. (inches of mercury), damage to the brake system will result and the brakes may become inoperable.

7.2.9. ACCESSORY BATTERY

Your trailer may be outfitted with an accessory battery that operates lighting, electric landing gear, slide-outs, or other accessories. An accessory battery may be kept charged either by the tow vehicle or by the generator or shore power. See the manual for the accessory battery.

A disconnect switch may be provided to disconnect the accessory battery when you do not plan to be using the trailer for an extended period, such as seasonal storage. If there is no disconnect switch, then remove the cables from the battery terminals.

The accessory battery must be kept in a charged condition during storage. The battery could freeze and break if it becomes discharged.

7.2.10. TIRES

Trailer tires may be worn out even though they still have plenty of tread left. This is because trailer tires have to carry a lot of weight all the time, even when not in use. It is actually better for the tire to be rolling down the road than to be idle. During use, the tire releases lubricants that are beneficial to tire life. Using the trailer tires often also helps prevent flat spots from developing.

The main cause of tire failure is improper inflation. Check the cold tire inflation pressures at least once a week for proper inflation levels. "Cold" means that the tires are at the same temperature as the surrounding air, such as when the vehicle has been parked overnight. Wheel and tire manufacturers recommend adjusting the air pressure to the trailer manufacturer's recommended cold inflation pressure, in pounds per square inch (PSI) stated on the vehicle's Federal Certification Label or Tire Placard when the trailer is loaded to its gross vehicle weight rating (GVWR). If the tires are inflated to less than the recommended inflation level or the GVWR of the trailer is exceeded, the load carrying capacity of the tire could be dramatically affected. If the tires are inflated more than the recommended inflation level, handling characteristics of the tow vehicle/trailer combination could be affected. Refer to the owner's manual or talk to your dealer or vehicle manufacturer if you have any questions regarding proper inflation practices.

Tires can lose air over a period of time. In fact, tires can lose 1 to 3 PSI per month. This is because molecules of air, under pressure, weave their way from the inside of the tire, through the rubber, to the outside. A drop in tire pressure could cause the tire to become overloaded, leading to excessive heat buildup. If a trailer tire is under-inflated, even for a short period of time, the tire could suffer internal damage.

High speed towing in hot conditions degrades trailer tires significantly. As heat builds up during driving, the tire's internal structure starts to breakdown, compromising the strength of the tire. It is recommended to drive at moderate speeds.

Statistics indicate the average life of a trailer tire is about five years under normal use and maintenance conditions. After three years, replacing the trailer tires with new ones should be considered, even if the tires have adequate tread depth. Some experts claim that after five years, trailer tires are considered worn out and should be replaced, even if they have had minimal or no use. This is such a general statement that it may not apply in all cases. It is best to have your tires inspected by a tire supplier to determine if your tires need to be replaced.

If you are storing your trailer for an extended period, make sure the tires are fully inflated to the maximum rated pressure and that you store them in a cool, dry place, such as a garage. Use tire covers to protect the trailer tires from the harsh effects of the sun.

^ WARNING
Worn, damaged or under-inflated tires can cause loss of control, resulting in damage, serious injury and possibly death.
Inspect tires before each tow.

7.2.11. WHEEL RIMS

If the trailer has been struck, or impacted, on or near the wheels, or if the trailer has struck a curb, inspect the rims for damage (i.e. being out of round); and replace any damaged wheel. Inspect the wheels for damage every year, even if no obvious impact has occurred.

7.2.12. WHEELS, BEARINGS AND LUG NUTS

A loose, worn, or damaged wheel bearing is the most common cause of brakes that grab.

To check your bearings, jack trailer and check wheels for side-to-side looseness. If the wheels are loose, or spin with a wobble, the bearings must be serviced or replaced.

Most trailer axles are built with sealed bearings that are not serviceable. Sealed bearings must be replaced as complete units.

7.2.12.1. UNSEALED BEARINGS (HUBS)

If your trailer has unsealed axle bearings, they must be inspected and lubricated once a year or 12,000 miles to insure safe operation of your trailer.

If a trailer wheel bearing is immersed in water, it must be replaced.

If your trailer has not been used for an extended amount of time, have the bearings inspected and packed more frequently, at least every six months and prior to use.

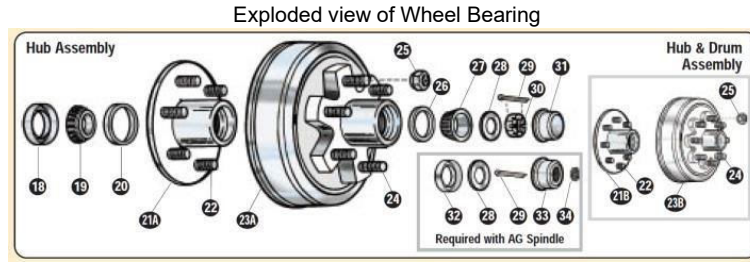

Follow the steps below to disassemble and service the UNSEALED wheel bearings.

- After removing the grease cap, cotter pin, spindle nut and spindle washer (items 28-31 in "Exploded Wheel Bearing" figure), remove the hub and drum to inspect the bearings for wear and damage.
- Replace bearings that have flat spots on rollers, broken roller cages, rust, or pitting. Always replace bearings and cups in sets. The inner and outer bearings are to be replaced at the same time.
- Replace seals that have nicks, tears, or wear.
- Lubricate the bearings with a high-quality EP-2 automotive wheel bearing grease.

Every time the wheel hub is removed, and the bearings are reassembled, follow the steps below to check the wheel bearings for free running and adjust.

- Turn the hub slowly, by hand, while tightening the spindle nut, until you can no longer turn the hub by hand.
- Loosen the spindle nut just until you are able to turn it (the spindle nut) by hand. Do not turn the hub while the spindle nut is loose.
- Put a new cotter pin through the spindle nut and axle.
- Check the adjustments. Both the hub and the spindle nut should be able to move freely (the spindle nut motion will be limited by the cotter pin).

7.2.12.2. LUG NUTS (BOLTS)

Being sure wheel mounting nuts (lug nuts) on trailer wheels are tight and properly torqued is an important responsibility that trailer owners and users need to be familiar with and practice. Inadequate and/or inappropriate wheel nut torque (tightness) is a major reason that lug nuts loosen in service. Loose lug nuts can rapidly lead to a wheel separation with potentially serious safety consequences.

Lug nuts are prone to loosen right after a wheel is mounted to a hub. When driving on a new or remounted wheel, check the lug nut tightness often during the first few hundred miles of the trailer's use, especially after the first 10, 25 and 50 miles of driving, before each tow, and at least twice per year thereafter.

^ WARNING
Lug nuts are prone to loosen after initial installation, which can lead to death or serious injury.
Check lug nuts for tightness on a new trailer or when wheel(s) have been remounted after the <u>first</u> 10, 25 and 50 miles of driving.

^ WARNING
Metal creep between the wheel rim and lug nuts will cause rim to loosen and could result in a wheel coming off, leading to death or serious injury.
Tighten lug nuts before each tow.

Tighten the lug nuts to the proper torque for the axle size on your trailer to prevent wheels from coming loose. Use a torque wrench to tighten the fasteners. The only way to be certain you have checked the torque or torqued the lug nuts to the proper torque is with a torque wrench. Four-way wrenches, ratchets, and similar tools can be useful for short-term emergency repairs but are not appropriate tools for adequately checking lug nut torque. You must use a torque wrench to adequately indicate the torque that you are applying to the lug nut. If you do not have a torque wrench, tighten the fasteners with a lug wrench as much as you can, then have a service garage or dealer tighten the lug nuts to the proper torque. Over-tightening will result in breaking the studs or permanently deforming the mounting stud holes in the wheels.

Figure 7-1 Lug Nut sequence of tightening

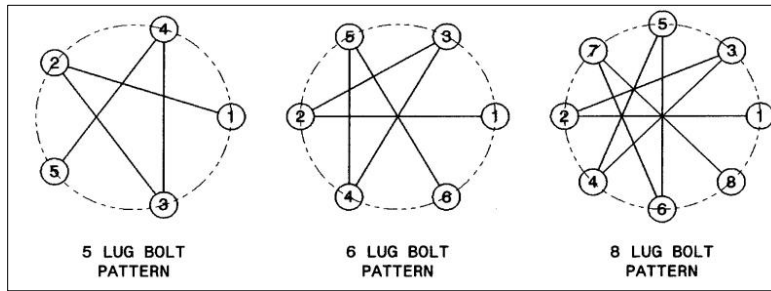

Keep a record of the date and approximate mileage when you check the lug nut torque. Note any lug nut that has lost torque. Investigate the reason(s) if the lug nut torque is not maintained after more than one re-torque application, because this indicates there is something wrong with the lug nuts, nut studs, wheels and/or hubs and should be corrected.

Contact your dealer or vehicle manufacturer immediately if you experience any persistent lug nut loosening or any other lug, wheel, or axle problems.

In the event of a wheel separation incident, notify the vehicle manufacturer and dealer. Seek prompt professional assistance in assessing the trailer and its gear, and retain, but don't re-use involved lugs, wheels, and studs. Do not repair or service the trailer yourself. Call a trained technician.

Lug Nut Torque – Steel Wheels		
Axle Rating Pounds	Stud Size	Dry Torque Foot pounds
3,500 to 7,000	1/2 inch	90-120 ft.-lb.
8,000	9/16 inch	120-140 ft.-lb.
9,000	5/8 inch	190-210 ft.-lb.
10,000	5/8 inch flanged	275-325 ft.-lb.

Lug Nut Torque – Aluminum Wheels		
Rim Size	Stud Size	Dry Torque Foot pounds
15 inch (5 or 6 hole)	1/2 inch	90-100 ft.-lb.
16 inch (8 hole)	1/2 inch	90-100 ft.-lb.

Dry Torque Foot-pounds is determined by manufacturer.

8. TANK-TRAILER INFORMATION

8.2 DIFFERENT FUEL TYPES USED IN TANKS

Tanks are designed for safe transport of nonflammable fuels.

(Transporting Gasoline fuel or AV-Gas inside the Tank will invalidate and void any and all warranties)

^ DANGER

Use of Flammable Fuels can result in an explosion and may lead to death or serious injury.

9. WARRANTY INFORMATION

1.1.1) Manufacturer's Warranty

Boss Trailers warrants that its product, to the original buyer, will be defect-free for a period of one year, *providing that the following conditions are met and satisfied.*

1.1.2) Warranty Covers

This warranty covers the primary frame of the trailer for a period of three years. Cross members, ramps, railings, and any other non-wearing items are covered for a period of one year. Items subject to normal wear will not be replaced due to wear.

These normal wear items include but are not limited to: surface paint, flooring, bearings, hoses, and brake linings.

Auxiliary parts such as calipers, jacks, tires, suspension, lights, brakes, wheels, gas engines with pumps, etc. are covered by the warranty of their respective manufacturer.

1.1.3) Limitations

The only responsibility of Boss Trailers under this limited warranty shall be to repair and replace parts at the Boss Trailers factory, or at a Boss Trailers authorized dealer. Warranty repairs performed at another location other than the Boss Trailers factory or authorized dealer are only allowed under this warranty with prior written approval by Boss Trailers.

Unless applicable state law provides otherwise, all other liabilities or obligations, including incidental or consequential damages or contingent liabilities stemming out of the failure of any parts to operate properly are hereby excluded, including but not limited to any damages resulting from loss of use, inconvenience, loss of time, commercial loss, or any other type of damages both specific and general, foreseen or unforeseen.

No claimant will be reimbursed by Boss Trailers for any repair or adjustment of a Boss Trailer without prior written approval by Boss Trailers, Labor costs will be reimbursed to a reasonable extent for any repairs performed at a location other than the Boss Trailers production facilities.

1.1.4) Warranty Void

Boss Trailers is not responsible for damages caused by abuse, misapplication, or negligence of a trailer or any of its individual component parts. Loads exceeding the gross vehicle load rating indicated on the product's certificate plate will invalidate and void any and all warranties. Transporting Gasoline fuel or AV-Gas inside Tank trailers will invalidate and void any and all warranties. Any trailer utilized as a rental unit or as part of a rental combination with rental equipment, will invalidate and void any and all warranties. Any repairs, alterations, or modifications to Boss Trailers products without the express written consent and prior knowledge of Boss Trailers will void manufacturer's warranty.

1.1.5) Transportation Costs Excluded

Boss Trailers shall not be held responsible for any trailer transportation costs to and/or from your dealer, the Boss Trailers factory, or an approved repair facility. These responsibilities lie with the trailer owner.

1.1.6) Disclaimers

This warranty is expressly given in place of all other representations and warranties. Boss Trailers makes no representation or warranty of any kind or type, express or implied with respect to Boss Trailers whether as to merchantability, fitness of a particular purpose or any other matter. No party, including an authorized Boss Trailers dealer is authorized to make further or additional warranties on behalf of Boss Trailers.

Boss Trailers makes no other implied or express warranties. There are no other warranties which extend beyond such stated.

1.1.7) Dealer Responsibilities

Responsibility for submitting any claim you wish to make to the manufacturer under this Limited Warranty lies with your authorized Boss Trailers dealer.

1.1.8) Warranty Claim Procedure

1. Within ten (10) days after discovering a problem with your Boss Trailers trailer, submit a Warranty Claim Form on Boss Trailer's website, www.bosstrailers.com or return your trailer to your dealer where you bought your trailer from for inspection.

2. If your dealer cannot repair the problem free of charge and you want to file a claim under this warranty, your local dealer must send to Boss Trailers a warranty claim form, together with all the required information within fifteen (15) days of the discovery of your defect.